



DESIGN EXAMPLE REPORT

Title	<i>Non-isolated 14 W LED Driver Using TNY279GN</i>
Specification	195 VAC – 265 VAC Input 20 V, 0.7 A CV/CC Output
Application	LED Lighting
Author	Power Integrations Applications Group
Document Number	DER-173
Date	April 4, 2008
Revision	1.2

Summary and Features

- High efficiency >85%
- Integrated TinySwitch-III Safety/Reliability features:
 - Accurate (+5%), auto-recovering, hysteretic thermal shutdown function maintains safe PCB temperatures under all conditions
 - Auto-restart protects against output short circuit and open loop fault conditions
 - 3.2 mm creepage on package enables reliable operation in high humidity and high pollution environments
- BP/M capacitor value selects MOSFET current limit for greater design flexibility
- Tightly toleranced I2f parameter (–10%, +12%) reduces system cost:
 - Increases MOSFET and magnetics power delivery
 - Reduces overload power, which lowers output diode and capacitor costs

The products and applications illustrated herein (including circuits external to the products and transformer construction) may be covered by one or more U.S. and foreign patents or potentially by pending U.S. and foreign patent applications assigned to Power Integrations. A complete list of Power Integrations' patents may be found at www.powerint.com.

Power Integrations

5245 Hellyer Avenue, San Jose, CA 95138 USA.

Tel: +1 408 414 9200 Fax: +1 408 414 9201

www.powerint.com

Table of Contents

1	Introduction	3
2	Power Supply Specification.....	4
3	Schematic	5
	Circuit Description.....	6
3.1	Input Rectification and Filtering	6
3.2	TNY279GN Operation	6
3.3	Output Rectification and Filtering	7
3.4	Feedback and Output Voltage Regulation.....	7
3.5	Peak Primary Current Limit Selection.....	7
4	Bill of Materials.....	8
5	Transformer Specification	9
5.1	Electrical Diagram	9
5.2	Mechanical Diagram.....	9
5.3	Electrical Specifications.....	9
5.4	Materials.....	10
5.5	Transformer Construction.....	10
6	Transformer Spreadsheet	11
7	Performance Data	14
7.1	Output Characteristic.....	14
7.2	No-Load Input Power	15
7.3	Efficiency	16
7.4	Load and Line Regulation.....	17
8	Waveforms.....	18
8.1	Drain Voltage and Current, Normal Operation.....	18
8.2	Drain Voltage and Current Start-up Profile	18
8.3	Output Voltage Start-up Profile.....	19
9	Output Ripple Measurements	20
9.1	Ripple Measurement Technique.....	20
9.1.1	Measurement results	21
10	Thermal Performance	22
11	Conducted EMI	23
12	Revision History	24

Important Note:

Although this PSU is designed to satisfy safety isolation requirements, the engineering prototype has not been agency approved. Therefore, all testing should be performed using an isolation transformer to provide the AC input to the prototype board.



1 Introduction

This engineering report describes a non-isolated 14 W output and high-line input voltage range (195 VAC–265 VAC) power supply utilizing the TNY279GN for an LED lighting application.

The LED array and enclosure were designed to provide safety isolation to the end user. Therefore the output of this design is not electrically isolated from the AC input.

This document contains the complete specification of the power supply, a detailed circuit diagram, the entire bill of materials required to build the supply, the transformer design, the test data, and the oscillographs of the power supply's most important electrical waveforms.

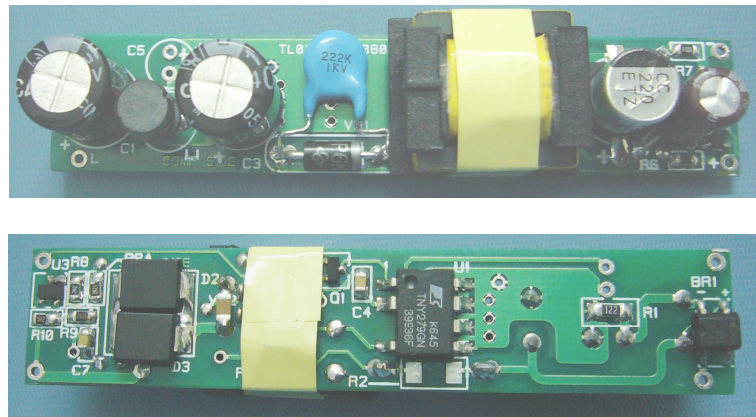

Figure 1 – Photographs of Power Supply.
(L = 80 mm; W = 16 mm; H = 17 mm including bottom side SMD components)

2 Power Supply Specification

Description	Symbol	Min	Typ	Max	Units	Comment
Input						
Voltage	V_{IN}	195		265	VAC	2 Wire – no P.E.
Frequency	f_{LINE}	47	50/60	64	Hz	
Output						
Output Voltage 1	V_{OUT1}	18	20	21	V	-10%, +5% 20 MHz bandwidth +/-7%
Output Ripple Voltage 1	$V_{RIPPLE1}$			600	mV	
Continuous load Current 1	I_{OUT1}	650	700	750	mA	
Output Power						
Continuous Output Power	P_{OUT}		14		W	
Efficiency						
Full load	η	85			%	Measured at P_{OUT} , 25 °C, 230V AC
Environmental						
Ambient Temperature	T_{AMB}	0		75	°C	Free convection, sea level



3 Schematic

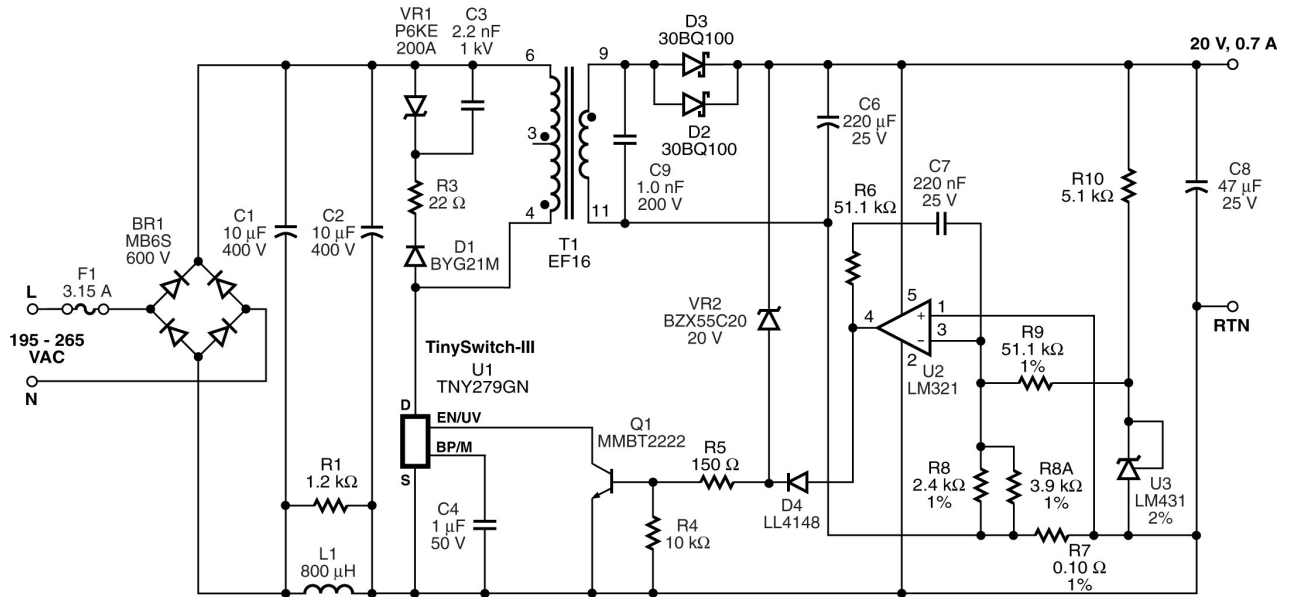

Figure 2 – Schematic.

PI-4980-040708

Circuit Description

This flyback power supply was designed around the TNY279GN (U1 in Figure 2). It is a Constant Voltage Constant Current (CV/CC) power supply for driving LED arrays.

3.1 Input Rectification and Filtering

Diode bridge module BR1 rectifies the AC input. Capacitors C1 and C2 filter the rectified DC. Inductor L1 and capacitors C1 and C2 form a pi filter that attenuates differential-mode conducted EMI. R1 is a damping resistor that reduces resonant ringing between C1, C2, and L1. Fuse F1 provides protection against catastrophic failure (such as a shorted bridge diode) on the primary side.

3.2 TNY279GN Operation

The TNY279GN device (U1) integrates an oscillator, a switch controller, startup and protection circuitry, and a power MOSFET, all on one monolithic IC.

One side of the power transformer (T1) primary winding is connected to the positive leg of C2, and the other side is connected to the DRAIN pin of U1. At the start of a switching cycle, the controller turns the MOSFET on, and current ramps up in the primary winding, causing energy to be stored in the transformer's core. When the current reaches the limit threshold, the controller turns the MOSFET off.

Due to the phasing of the transformer windings and the orientation of the output diode, the stored energy induces a voltage across the secondary winding, which forward biases the output diodes D2 and D3, and causes the stored energy to be delivered to the output capacitor C6. When the MOSFET turns off, the leakage inductance of the transformer induces a voltage spike on the drain node. The amplitude of the voltage spike is limited by a simple clamp network consisting of blocking diode D1, transient voltage suppressor VR1, capacitor C3, and resistor R3.

Using ON/OFF control, U1 skips switching cycles to regulate the output voltage, based on feedback to its EN/UV pin. The EN/UV pin current is sampled, just prior to each switching cycle, to determine if that switching cycle should be enabled or disabled. If the current out of the EN/UV pin is less than 115 μ A, the next switching cycle begins, and is terminated when the current through the MOSFET reaches the internal current limit threshold. To evenly spread switching cycles and prevent group pulsing, the EN/UV pin threshold current is modulated between 115 μ A and 75 μ A, based on the state during the previous cycle. A state machine within the controller adjusts the MOSFET current limit threshold to one of four levels, depending on the load being demanded from the supply. As the load on the supply drops, the current limit is reduced. This ensures the effective switching frequency stays above the audible range until the transformer flux density is low. Using the standard production technique of dip varnishing for the transformer essentially eliminates the audible noise.



3.3 Output Rectification and Filtering

Diodes D2 and D3 rectify the output of T1. Output voltage ripple was minimized by using a low ESR capacitor for C6. Capacitor C9 is a ceramic disk capacitor used to reduce both conducted as well as radiated EMI.

3.4 Feedback and Output Voltage Regulation

The constant voltage (CV) characteristic provided by Zener diode VR2 regulates the output voltage to approximately 21 V at no-load.

The constant current (CC) characteristic is achieved by directly sensing the load current. The shunt regulator IC (U3) generates an accurate voltage reference which is divided down by R9, R8 and R8A to 0.07 V at the inverting input of op-amp U2. This improves efficiency by providing low drop-voltage sensing using the output current. Capacitor C7 and resistor R6 provide loop compensation. The load (LED) current is sensed by resistor R7. At the programmed current, the voltage across R7 exceeds the reference voltage causing the op-amp output to rise. This forward biases D4 driving the base of Q1 which pulls current out of the EN/UV pin of U1. Resistor R10 provides the supply current for U3.

3.5 Peak Primary Current Limit Selection

The value of the capacitor (C4) between the BP/M pin and the SOURCE pins allows the power supply designer to select the current limit of U1. The designer can change the current limit of the MOSFET by simply changing C4's capacitance to one of three choices: 0.1 μF , 1 μF , or 10 μF . These values correspond to three MOSFET current limits; standard, reduced, and increased, respectively.

Standard mode is the normal choice for enclosed adapter applications. However, the high ambient temperature requirement (75 °C) for this design uses the reduced current limit, which corresponds to a 1 μF capacitor for C4. This maximizes U1's efficiency, lowers conduction losses, and reduces its temperature rise.

Using a 10 μF capacitor for C4 (increased current limit) raises the MOSFET current limit and extends the power capability of the IC. This is for higher power applications that do not have the thermal constraints of an enclosed adapter, or to supply short-duration, peak load demands. (See the TinySwitch-III data sheet for more details.)



4 Bill of Materials

Item	Qty	Part Ref	Description	Mfg	Mfg Part Number
1	1	BR1	600 V, 0.5 A, Bridge Rectifier, SMD, TO-269AA(MBS)	Vishay	MB6S
2	2	C1, C2	10 μ F, 400 V, Electrolytic, Low ESR, 79 mA, (10 x 12.5), 105C	Ltec	TYD2GM100G130
3	1	C3	2.2 nF, 1 kV, Disc Ceramic	Panasonic	ECKA3A222KBP
4	1	C4	1 μ F, 50 V, Ceramic, X7R, 0805	Panasonic	ECJ-2YB1H105K
5	1	C6	220 μ F, 25 V, Electrolytic, (8 x 10.5), SMD, 105C	Rubycon	25TZV220M8X10.5
6	1	C7	220 nF, 25 V, Ceramic, X7R, 0805	Panasonic	ECJ-2YB1E224K
7	1	C8	47 μ F, 25 V, Electrolytic, 105C	Nippon Chemicon	KMG series
8	1	C9	1.0 nF, 200V, 1206, 5%	Walsin	1206102J201CT
9	1	D1	1000 V, 1 A, Fast Recovery, 120 ns, SMA	Vishay	BYG21M
10	2	D2, D3	100 V, 3 A, Schottky, SMC	Vishay	30BQ100
11	1	D4	75 V, 0.15 A, Fast Switching, 4 ns, MELF	Diode Inc.	LL4148-13
12	1	L1	800 μ H, 0.15 A, 6 X 8, Drum choke	Prismatic	26801
13	1	R1	1.2 k Ω R, 5%, 1/4 W, Metal Film, 1206	Panasonic	ERJ-8GEYJ122V
14	1	R3	22 R, 5%, 1/4 W, Metal Film, 1206	Panasonic	ERJ-8GEYJ220V
15	1	R4	10 k Ω , 5%, 1/8 W, Metal Film, 0805	Panasonic	ERJ-6GEYJ103V
16	1	R5	150 R, 5%, 1/8 W, Metal Film, 0805	Panasonic	ERJ-6GEYJ151V
17	2	R6, R9	51.1 k Ω , 1%, 1/8 W, Metal Film, 0805	Panasonic	ERJ-6ENF5112V
18	1	R10	5.1 k Ω , 5%, 1/8 W, Metal Film, 0805	Panasonic	ERJ-6GEYJ512V
19	1	R7	0.10 R, 1%, 1/4 W, Metal Film, 0805	Phycomp	23505117107
20	1	R8	2.4 k Ω , 1%, 1/8 W, Metal Film, 0805	Panasonic	ERJ-6ENF2401V
21	1	R8A	3.9 k Ω , 1%, 1/8 W, Metal Film, 0805	Panasonic	ERJ-6ENF3901V
22	1	T1	Bobbin, EE16/8/5, Horizontal (EF16)	-	-
23	1	U1	TinySwitch-III, TNY279GN, SMD-8C	Power Integrations	TNY279GN
24	1	U2	OP AMP SINGLE LOW PWR SOT23-5	National Semiconductor	LM321MF
25	1	U3	2.495 V Shunt Regulator IC, 2%, -40 to 85C, SOT23	National Semiconductor	LM431AIM
26	1	Q1	NPN, Medium Power BJT, 40 V, 0.6 A, SOT-23	Philips	MMBT2222A
27	1	VR1	200 V, 5 W, 5%, DO204AC (DO-15)	Vishay	P6KE200A
28	1	VR2	20 V, 5%, 500 mW, DO-35	Vishay	BZX55C20
29	1	-	PCB, 0.8mm thick, 35 microns	-	-



5 Transformer Specification

5.1 Electrical Diagram

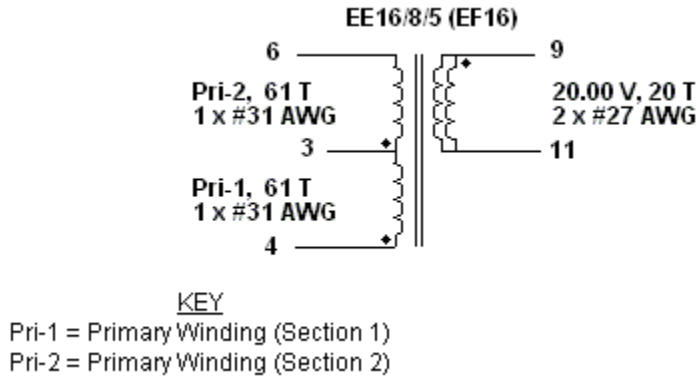

Figure 3 – Transformer Electrical Drawing.

5.2 Mechanical Diagram

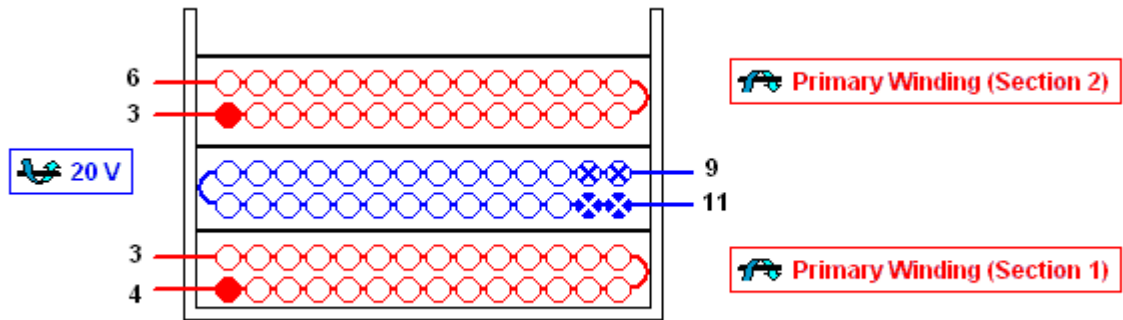

Figure 4 – Transformer Mechanical Drawing.

5.3 Electrical Specifications

Parameter	Condition	Spec
Electrical Strength, VAC	60 Hz, 1 second, from pin 1 – 6 to 7 – 12.	500
Nominal Primary Inductance, μ H	Measured at 1 V pk-pk, typical switching frequency, between pin 4 to 6, with all other Windings open.	1082 \pm 10%
Primary Leakage, μ H	Measured between pin 4 to 6, with all other Windings shorted.	26.11



5.4 Materials

Item	Description
[1]	Core: EE16/8/5 (EF16), NC-2H or Equivalent, gapped for ALG of 73 nH/t ²
[2]	Bobbin: Generic EE16/8/5, 6 pri. + 6 sec. (Low profile, 12mm height max)
[3]	Barrier Tape: Polyester film 8.60 mm wide
[4]	Varnish
[5]	Magnet Wire: 31 AWG, Solderable Double Coated
[6]	Magnet Wire: 27 AWG, Solderable Double Coated

5.5 Transformer Construction

Primary Winding (Section 1)	Start on pin - 4 and wind 61 turns (x 1 filar) of item [5] in 2 layer(s) from left to right. At the end of 1st layer, continue to wind the next layer from right to left. On the final layer, spread the winding evenly across entire bobbin. Finish this winding on pin - 3.
Tape	Add 1 layer of tape, item [3], for insulation.
Secondary Winding	Start on pin - 11 and reverse wind 20 turns (x 2 filar) of item [6] in 2 layer(s) from right to left. At the end of 1st layer, continue to wind the next layer from left to right. Spread the winding evenly across entire bobbin. Wind in opposite rotational direction as primary winding. Finish this winding on pin - 9.
Tape	Add 1 layer of tape, item [3], for insulation.
Primary Winding (Section 2)	Start on pin - 3 and wind 61 turns (x 1 filar) of item [5] in 2 layer(s) from left to right. At the end of 1st layer, continue to wind the next layer from right to left. On the final layer, spread the winding evenly across entire bobbin. Finish this winding on pin - 6.
Tape	Add 1 layer of tape, item [3], for insulation.
Core Assembly	Assemble and secure core halves. Item [1].
Varnish	Dip varnish uniformly in item [4]. Do not vacuum impregnate.



6 Transformer Spreadsheet

ACDC_TinySwitch-III_022007; Rev.1.24; Copyright Power Integrations 2007	INPUT	INFO	OUTPUT	UNIT	ACDC_TinySwitch-III_022007_Rev1-24.xls; TinySwitch-III Continuous/Discontinuous Flyback Transformer Design Spreadsheet
ENTER APPLICATION VARIABLES					Customer
VACMIN	195			Volts	Minimum AC Input Voltage
VACMAX	265			Volts	Maximum AC Input Voltage
fL	47			Hertz	AC Mains Frequency
VO	20.00			Volts	Output Voltage (at continuous power)
IO	0.76			Amps	Power Supply Output Current (corresponding to peak power)
Power			15.2	Watts	Continuous Output Power
n	0.86				Efficiency Estimate at output terminals. Under 0.7 if no better data available
Z	1.00				Z Factor. Ratio of secondary side losses to the total losses in the power supply. Use 0.5 if no better data available
tC	3.00			mseconds	Bridge Rectifier Conduction Time Estimate
CIN	20.00		20	uFarads	Input Capacitance
ENTER TinySwitch-III VARIABLES					
TinySwitch-III	TNY279P		TNY279P		User defined TinySwitch-III
<i>Chosen Device</i>		TNY279P			
Chose Configuration	RED		Reduced Current Limit		Enter "RED" for reduced current limit (sealed adapters), "STD" for standard current limit or "INC" for increased current limit (peak or higher power applications)
ILIMITMIN			0.512	Amps	Minimum Current Limit
ILIMITTYP			0.550	Amps	Typical Current Limit
ILIMITMAX			0.610	Amps	Maximum Current Limit
fSmin			124000	Hertz	Minimum Device Switching Frequency
I ² fmin			35.937	A ² kHz	I ² f (product of current limit squared and frequency is trimmed for tighter tolerance)
VOR	125.00		125	Volts	Reflected Output Voltage (VOR < 135 V Recommended)
VDS			10	Volts	TinySwitch-III on-state Drain to Source Voltage
VD	0.50		0.5	Volts	Output Winding Diode Forward Voltage Drop
KP			1.31		Ripple to Peak Current Ratio (KP < 6)
KP_TRANSIENT			0.89		Transient Ripple to Peak Current Ratio. Ensure KP_TRANSIENT > 0.25
ENTER BIAS WINDING VARIABLES					
VB	0		0.00	Volts	Bias Winding Voltage
VDB	0		0.00	Volts	Bias Winding Diode Forward Voltage Drop
NB			0.00		Bias Winding Number of Turns
VZOV	0		0.00	Volts	Over Voltage Protection zener diode voltage.
UVLO VARIABLES					
V_UV_TARGET	0		0.00	Volts	Target DC under-voltage threshold, above which the power supply will start
V_UV_ACTUAL			#N/A	Volts	Typical DC start-up voltage based on standard value of RUV_ACTUAL
RUV_IDEAL			-0.09	MOhms	Calculated value for UV Lockout resistor
RUV_ACTUAL			#N/A	MOhms	Closest standard value of resistor to RUV_IDEAL



ENTER TRANSFORMER CORE/CONSTRUCTION VARIABLES					
Core Type	EF16		EF16		Enter Transformer Core
Core		EF16		P/N:	PC40EF16-Z
Bobbin		EF16_BOBBIN		P/N:	EF16_BOBBIN
AE			0.201	cm ²	Core Effective Cross Sectional Area
LE			3.76	cm	Core Effective Path Length
AL	1100.00		1100	nH/T ²	Ungapped Core Effective Inductance
BW			10	mm	Bobbin Physical Winding Width
M			0	mm	Safety Margin Width (Half the Primary to Secondary Creepage Distance)
L	4.00		4		Number of Primary Layers
NS	20		20		Number of Secondary Turns
DC INPUT VOLTAGE PARAMETERS					
VMIN			250	Volts	Minimum DC Input Voltage
VMAX			375	Volts	Maximum DC Input Voltage
CURRENT WAVEFORM SHAPE PARAMETERS					
DMAX			0.28		Duty Ratio at full load, minimum primary inductance and minimum input voltage
Iavg			0.07	Amps	Average Primary Current
IP			0.51	Amps	Minimum Peak Primary Current
IR			0.51	Amps	Primary Ripple Current
IRMS			0.19	Amps	Primary RMS Current
TRANSFORMER PRIMARY DESIGN PARAMETERS					
LP			1082	uHenries	Typical Primary Inductance. +/- 10% to ensure a minimum primary inductance of 983 uH
LP_TOLERANCE	10.00		10	%	Primary inductance tolerance
NP			122		Primary Winding Number of Turns
ALG			73	nH/T ²	Gapped Core Effective Inductance
BM			2693	Gauss	Maximum Operating Flux Density, BM<3000 is recommended
BAC			1346	Gauss	AC Flux Density for Core Loss Curves (0.5 X Peak to Peak)
ur			1637		Relative Permeability of Ungapped Core
LG			0.32	mm	Gap Length (Lg > 0.1 mm)
BWE			40	mm	Effective Bobbin Width
OD	0.30		0.30	mm	Maximum Primary Wire Diameter including insulation
INS			0.05	mm	Estimated Total Insulation Thickness (= 2 * film thickness)
DIA			0.25	mm	Bare conductor diameter
AWG			31	AWG	Primary Wire Gauge (Rounded to next smaller standard AWG value)
CM			81	Cmils	Bare conductor effective area in circular mils
CMA			436	Cmils/Amp	Primary Winding Current Capacity (200 < CMA < 500)
TRANSFORMER SECONDARY DESIGN PARAMETERS					
Lumped parameters					
ISP			3.12	Amps	Peak Secondary Current
ISRMS			1.60	Amps	Secondary RMS Current
IRIPPLE			1.40	Amps	Output Capacitor RMS Ripple Current
CMS			319	Cmils	Secondary Bare Conductor minimum circular mils
AWGS			25	AWG	Secondary Wire Gauge (Rounded up to next larger standard AWG value)



VOLTAGE STRESS PARAMETERS					
VDRAIN			657	Volts	Maximum Drain Voltage Estimate (Assumes 20% zener clamp tolerance and an additional 10% temperature tolerance)
PIVS			81	Volts	Output Rectifier Maximum Peak Inverse Voltage
TRANSFORMER SECONDARY DESIGN PARAMETERS (MULTIPLE OUTPUTS)					
1st output					
VO1			20	Volts	Main Output Voltage (if unused, defaults to single output design)
IO1			0.760	Amps	Output DC Current
PO1			15.20	Watts	Output Power
VD1			0.5	Volts	Output Diode Forward Voltage Drop
NS1			20.00		Output Winding Number of Turns
ISRMS1			1.596	Amps	Output Winding RMS Current
IRIPPLE1			1.40	Amps	Output Capacitor RMS Ripple Current
PIVS1			81	Volts	Output Rectifier Maximum Peak Inverse Voltage
Recommended Diodes			UF5401, SB3100		Recommended Diodes for this output
CMS1			319	Cmils	Output Winding Bare Conductor minimum circular mils
AWGS1			25	AWG	Wire Gauge (Rounded up to next larger standard AWG value)
DIAS1			0.46	mm	Minimum Bare Conductor Diameter
ODS1			0.50	mm	Maximum Outside Diameter for Triple Insulated Wire
Total power			15.2	Watts	Total Output Power



7 Performance Data

All measurements performed at room temperature, 50 Hz input frequency with resistive load.

7.1 Output Characteristic

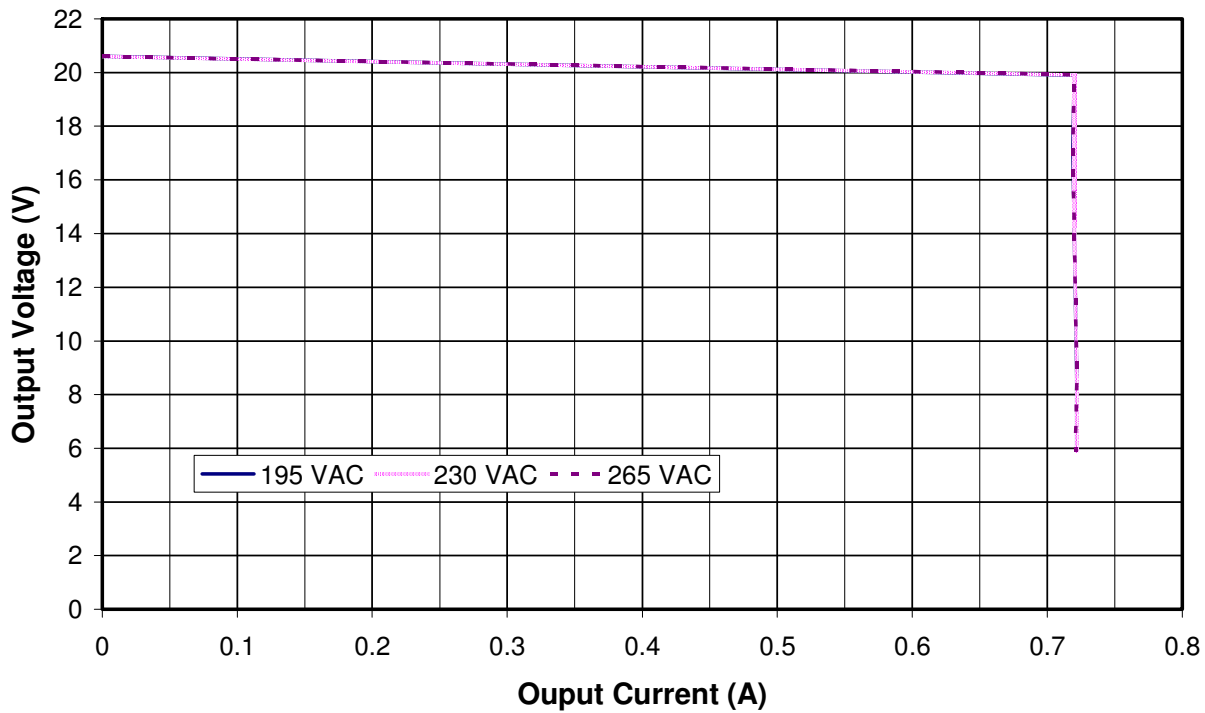

Figure 5 – Output CVCC Characteristic.

Note: The plots for all three VAC input conditions show the same output voltage vs. output current results.



7.2 No-Load Input Power

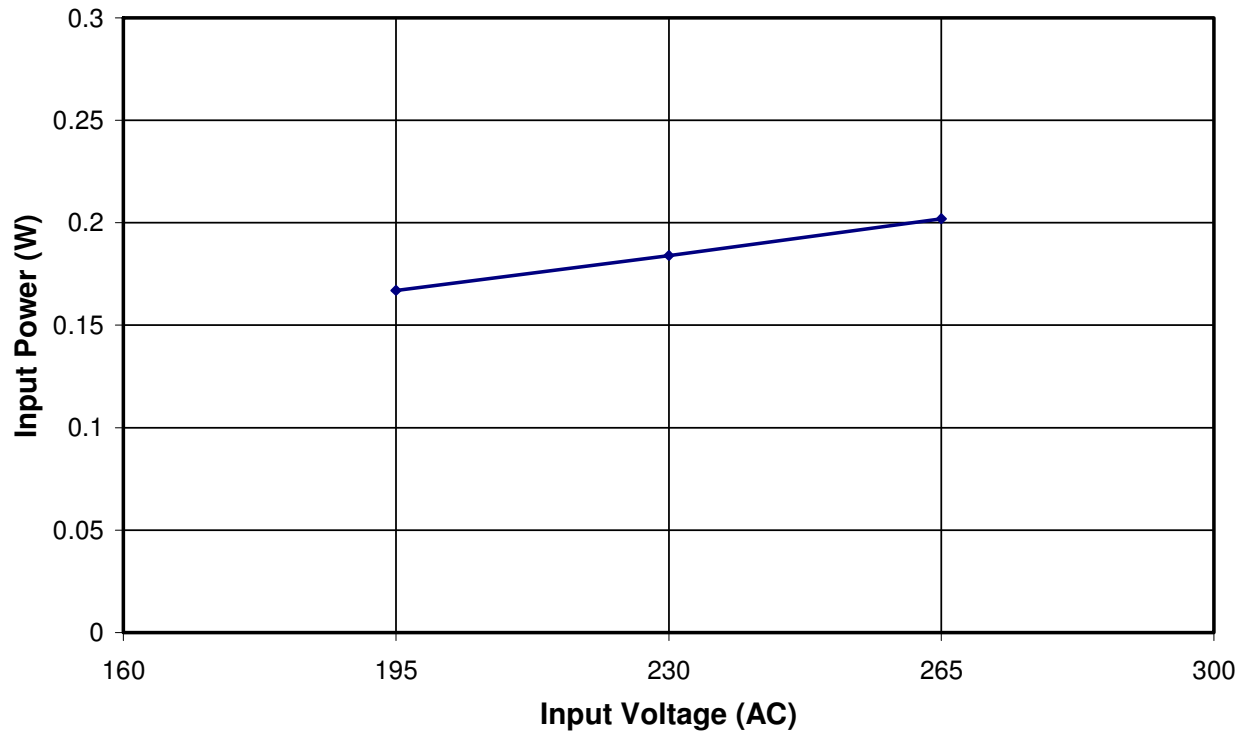

Figure 6 – No Load Input Power vs Line Input Voltage (VAC).



7.3 Efficiency

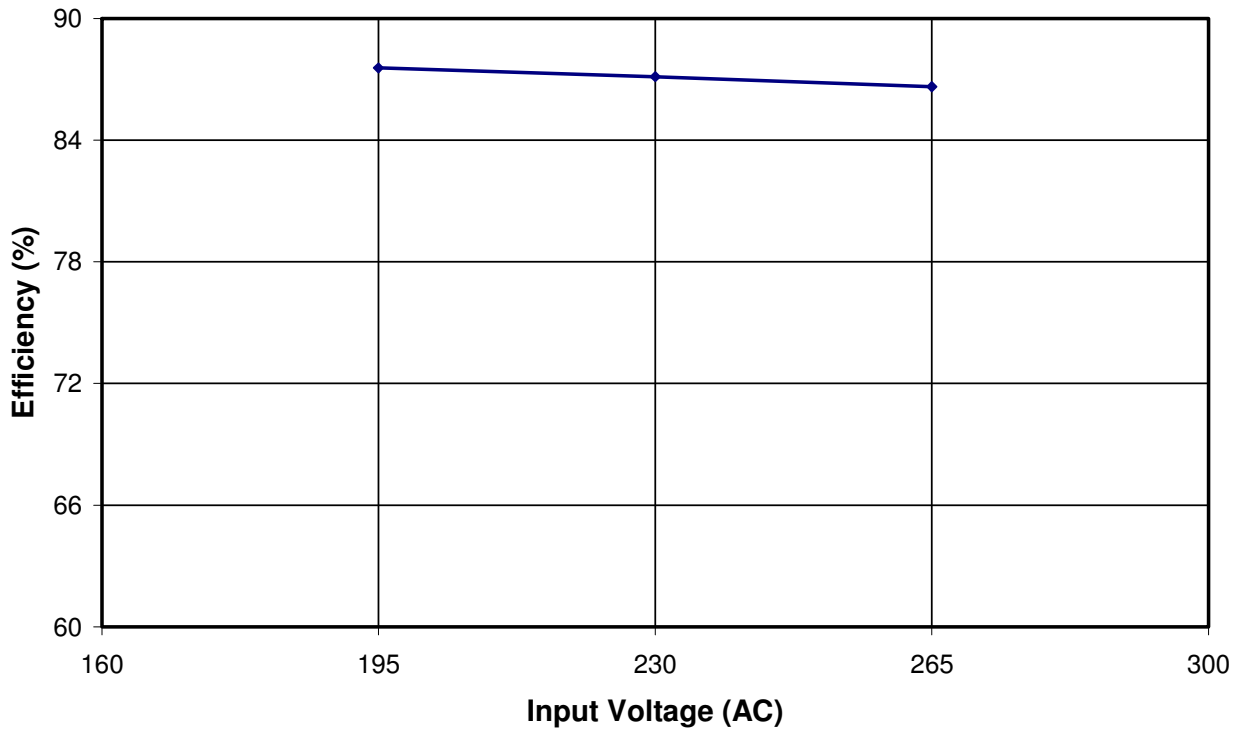

Figure 7 – Efficiency Vs Input Voltage at Full Load Condition.



7.4 Load and Line Regulation

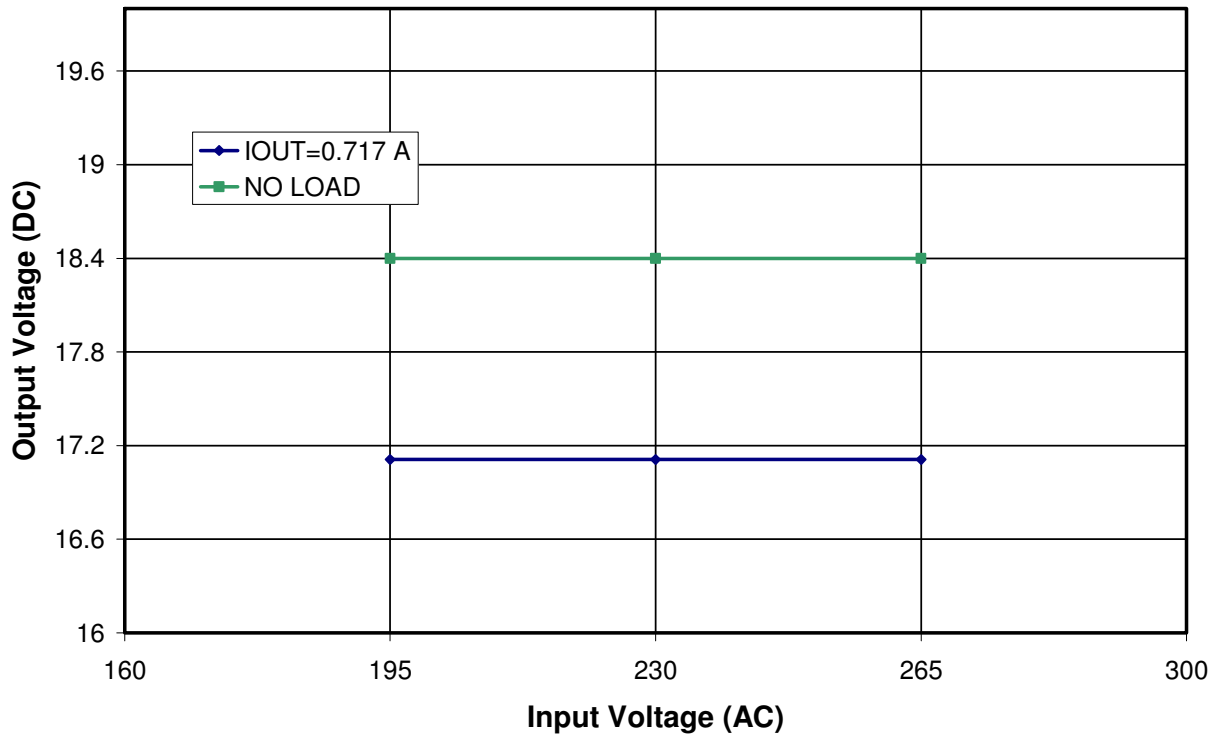

Figure 8 – Output voltage Vs Input Voltage with Varing Load Condition.



8 Waveforms

All measurements performed at room temperature, 50 Hz input frequency with an LED array as load. (17 V @ 0.7 A)

8.1 Drain Voltage and Current, Normal Operation

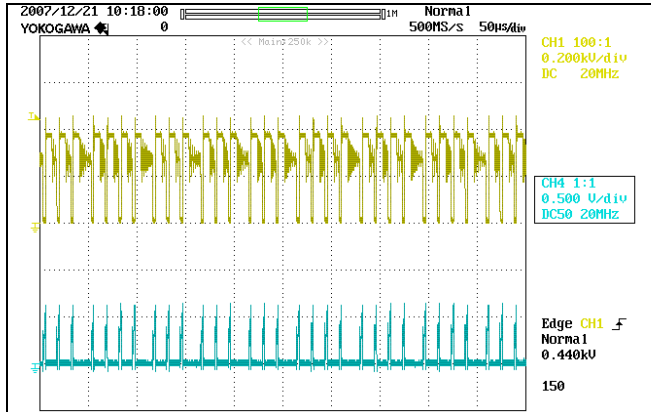

Figure 9 – 195 VAC, LED Load.
Upper: V_{DRAIN} , 200 V / div.
Lower: I_{DRAIN} , 0.5 A / div, 50 μ s / div.

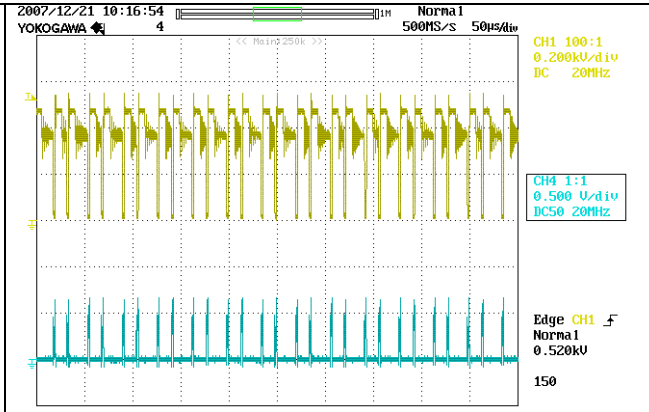

Figure 10 – 265 VAC, LED Load.
Upper: V_{DRAIN} , 200 V / div.
Lower: I_{DRAIN} , 0.5 A / div, 50 μ s / div.

8.2 Drain Voltage and Current Start-up Profile

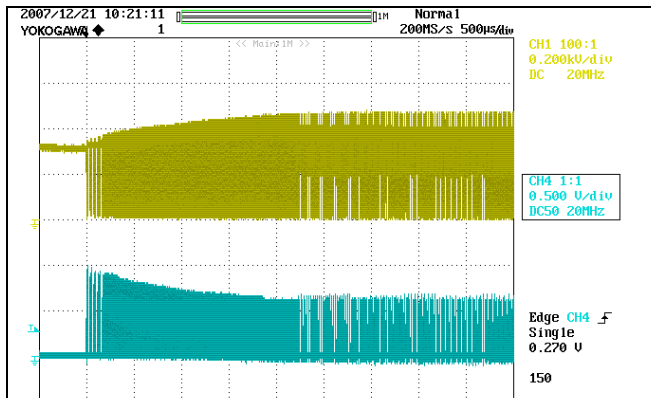

Figure 11 – 195 VAC, LED Load.
Upper: V_{DRAIN} , 200 V / div.
Lower: I_{DRAIN} , 0.5 A / div, 500 μ s / div.

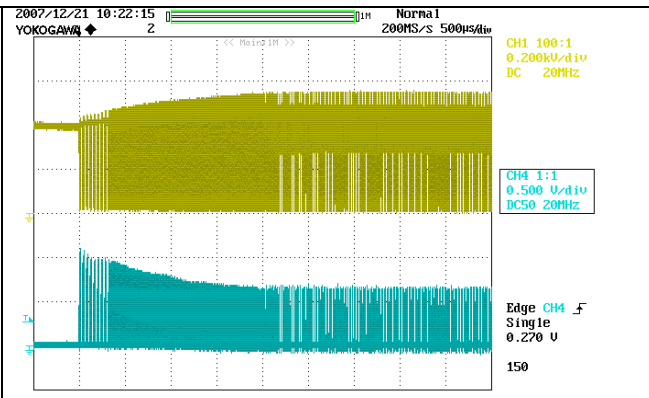
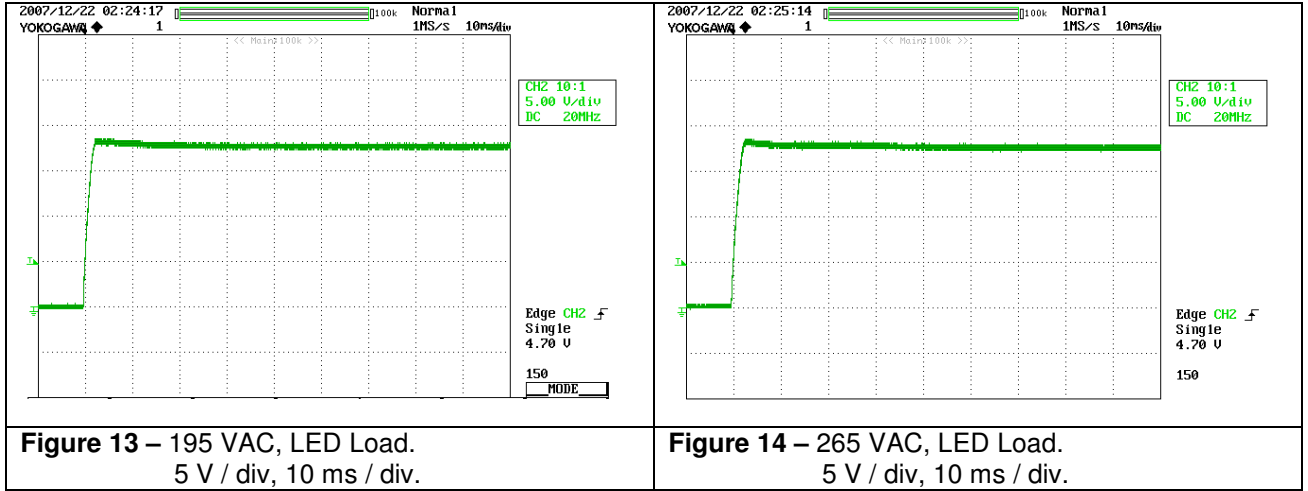

Figure 12 – 265 VAC, LED Load.
Upper: V_{DRAIN} , 200 V / div.
Lower: I_{DRAIN} , 0.5 A / div, 500 μ s / div.



8.3 Output Voltage Start-up Profile



9 Output Ripple Measurements

9.1 Ripple Measurement Technique

For DC output ripple measurements, use a modified oscilloscope test probe to reduce spurious signals. Details of the probe modification are provided in the figures below.

Tie two capacitors in parallel across the probe tip of a 4987BA probe adapter. The capacitors include one (1) 0.1 μF /50 V ceramic type and one (1) 1.0 μF /50 V aluminum electrolytic. The aluminum-electrolytic capacitor is polarized, so always maintain proper polarity across DC outputs (see Figure 15 and Figure 16).



Figure 15 – Oscilloscope Probe Prepared for Ripple Measurement. (End Cap and Ground Lead Removed).

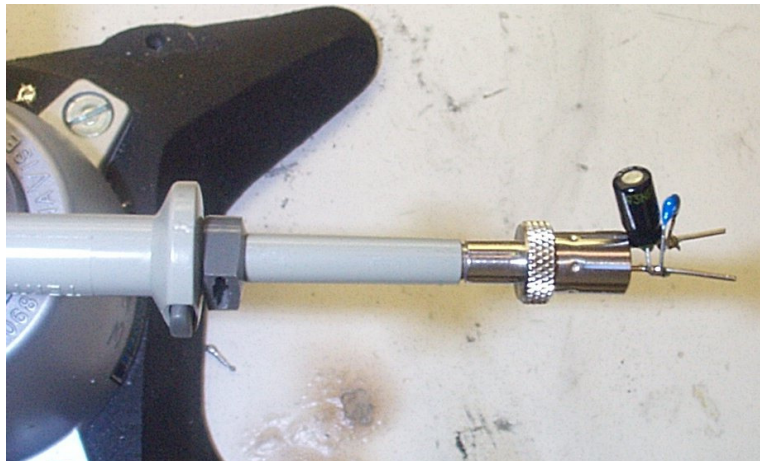

Figure 16 – Oscilloscope Probe with Probe Master (www.probemaster.com) 4987A BNC Adapter. (Modified with wires for ripple measurement, and two parallel decoupling capacitors added)

9.1.1 Measurement results

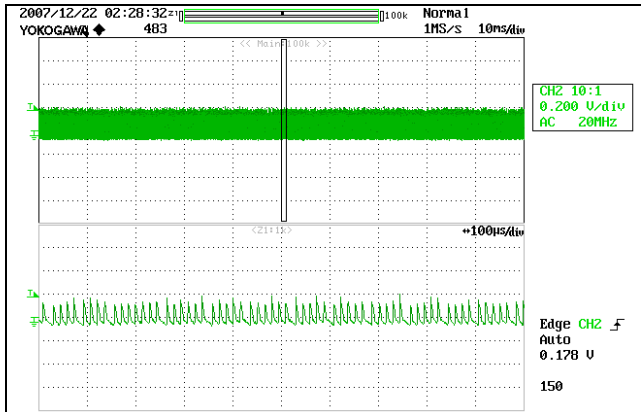

Figure 17 – 195 VAC, LED Load.
 Upper: Normal, 0.2 V / div, 10 ms / div.
 Lower: Zoom, 0.2 V / div, 100 us / div.

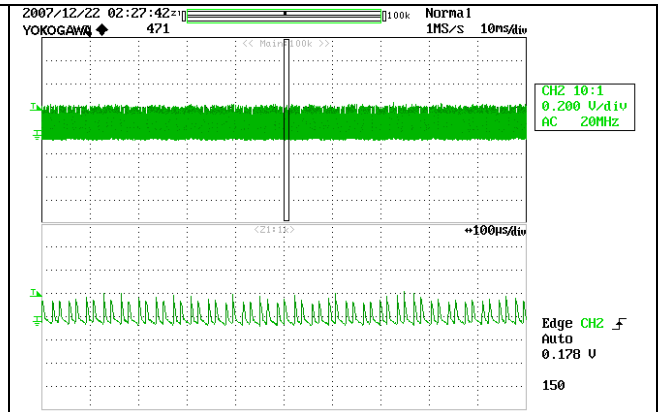

Figure 18 – 265 VAC, LED Load.
 Upper: Normal, 0.2 V / div, 10 ms / div.
 Lower: Zoom, 0.2 V / div, 100 us / div.

10 Thermal Performance

Temperature measurements of key components were taken using T-type thermocouples. The thermocouples made contact with the components using high-temperature-withstanding glue-type tape and heatsink compound.

The power-supply unit was sealed inside a tube and its ends were closed to eliminate any airflow. The unit was operated with an LED array load. Temperature measurements were taken after they stabilized for 1 hour at 85 °C ambient temperature.

Temperature (°C)		
Item	195 VAC	265 VAC
Tube inside Ambient	85	84
Input Bulk cap (C2)	101	99
Primary TVS (VR1)	105	106
TNY279GN (U1)	108	113
Transformer EE16 (T1)	114	117
Output cap (C6)	105	106
Output diode (D2)	113	114
Input power (watts)	13.01	13.12
Output Voltage (volts)	16.95	16.94
Output current (amps)	0.665	0.663

Thermal shutdown occurs at 107 °C ambient, which indicates 20 °C operating margin (in ambient temperature) for TNY279GN. However, the power supply's electrolytic capacitors are operating at their maximum ratings.

Note: To use this design in a product, use capacitors with sufficiently high temperature ratings, to ensure high Mean Time Between Failure (MTBF) ratings.



11 Conducted EMI

Conducted emissions tests were performed with an LED array load (17 V / 0.7 A) at 230 VAC input.

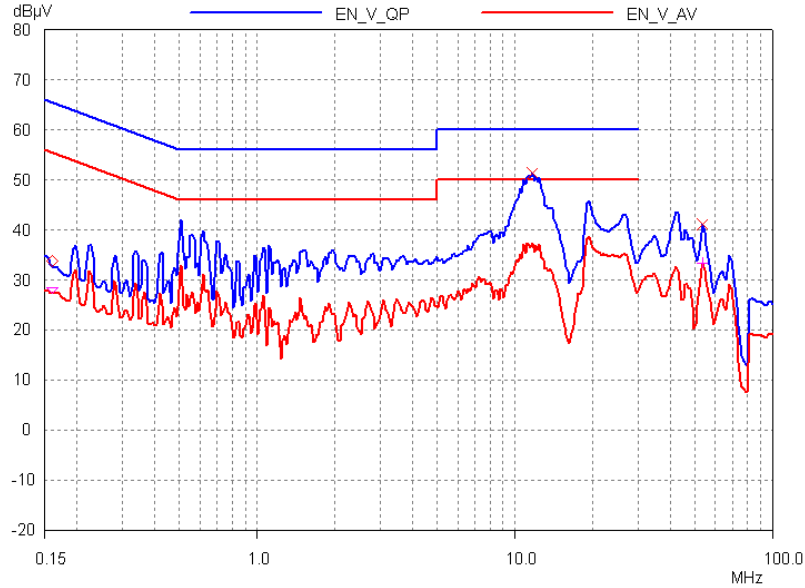

Figure 19 – Conducted EMI, 230 V AC, Line, LED load. EN55022Q: QP limit; EN55022A: Average limit. Blue: QP scan; Red: Average scan.

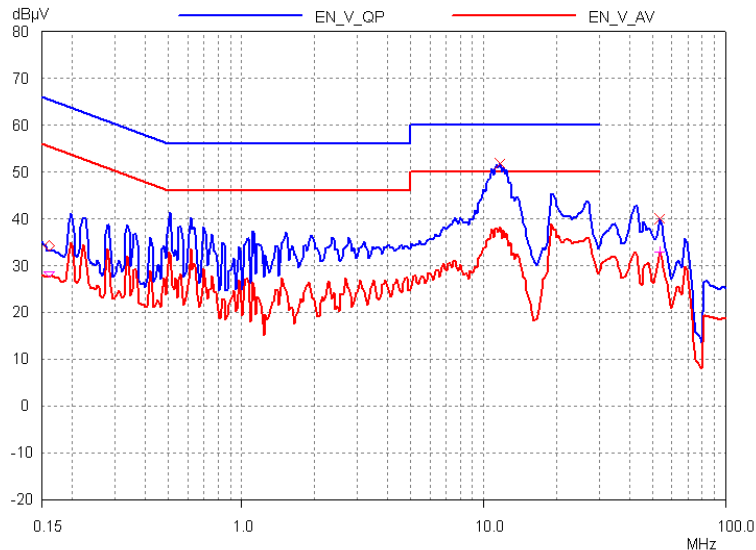

Figure 20 – Conducted EMI, 230 V AC, Neutral, LED load. EN55022Q: QP limit; EN55022A: Average limit; Blue: QP scan; Red: Average scan.



12 Revision History

Date	Author	Revision	Description & changes	Reviewed
4-Apr-08	JD	1.2	First Release	JD/SGK



Notes



Notes



Notes



For the latest updates, visit our website: www.powerint.com

Power Integrations reserves the right to make changes to its products at any time to improve reliability or manufacturability. Power Integrations does not assume any liability arising from the use of any device or circuit described herein. POWER INTEGRATIONS MAKES NO WARRANTY HEREIN AND SPECIFICALLY DISCLAIMS ALL WARRANTIES INCLUDING, WITHOUT LIMITATION, THE IMPLIED WARRANTIES OF MERCHANTABILITY, FITNESS FOR A PARTICULAR PURPOSE, AND NON-INFRINGEMENT OF THIRD PARTY RIGHTS.

PATENT INFORMATION

The products and applications illustrated herein (including transformer construction and circuits external to the products) may be covered by one or more U.S. and foreign patents, or potentially by pending U.S. and foreign patent applications assigned to Power Integrations. A complete list of Power Integrations' patents may be found at www.powerint.com. Power Integrations grants its customers a license under certain patent rights as set forth at <http://www.powerint.com/ip.htm>.

The PI Logo, TOPSwitch, TinySwitch, LinkSwitch, DPA-Switch, PeakSwitch, EcoSmart, Clampless, E-Shield, Filterfuse, StackFET, PI Expert and PI FACTS are trademarks of Power Integrations, Inc. Other trademarks are property of their respective companies. ©Copyright 2008 Power Integrations, Inc.

Power Integrations Worldwide Sales Support Locations

WORLD HEADQUARTERS

5245 Hellyer Avenue
San Jose, CA 95138, USA.
Main: +1-408-414-9200
Customer Service:
Phone: +1-408-414-9665
Fax: +1-408-414-9765
e-mail: usasales@powerint.com

GERMANY

Rueckertstrasse 3
D-80336, Munich
Germany
Phone: +49-89-5527-3911
Fax: +49-89-5527-3920
e-mail: eurosales@powerint.com

JAPAN

Kosei Dai-3 Bldg.,
2-12-11, Shin-Yokohama,
Kohoku-ku, Yokohama-shi,
Kanagawa 222-0033
Phone: +81-45-471-1021
Fax: +81-45-471-3717
e-mail: japansales@powerint.com

TAIWAN

5F, No. 318, Nei Hu Rd., Sec. 1
Nei Hu Dist.
Taipei, Taiwan 114, R.O.C.
Phone: +886-2-2659-4570
Fax: +886-2-2659-4550
e-mail: taiwansales@powerint.com

CHINA (SHANGHAI)

Rm 1601/1610, Tower 1,
Kerry Everbright City
No. 218 Tianmu Road West,
Shanghai, P.R.C. 200070
Phone: +86-21-6354-6323
Fax: +86-21-6354-6325
e-mail: chinasales@powerint.com

INDIA

#1, 14th Main Road
Vasanthanagar
Bangalore-560052 India
Phone: +91-80-41138020
Fax: +91-80-41138023
e-mail: indiasales@powerint.com

KOREA

RM 602, 6FL
Korea City Air Terminal B/D,
159-6
Samsung-Dong, Kangnam-
Gu,
Seoul, 135-728, Korea
Phone: +82-2-2016-6610
Fax: +82-2-2016-6630
e-mail: koreasales@powerint.com

UNITED KINGDOM

1st Floor, St. James's House
East Street, Farnham
Surrey, GU9 7TJ
United Kingdom
Phone: +44 (0) 1252-730-141
Fax: +44 (0) 1252-727-689
e-mail: eurosales@powerint.com

CHINA (SHENZHEN)

Rm A, B & C 4th Floor, Block C,
Electronics Science and
Technology Building, 2070
Shennan Zhong Rd,
Shenzhen, Guangdong,
China, 518031
Phone: +86-755-8379-3243
Fax: +86-755-8379-5828
e-mail: chinasales@powerint.com

ITALY

Via De Amicis 2
20091 Bresso MI – Italy
Phone: +39-028-928-6000
Fax: +39-028-928-6009
e-mail: eurosales@powerint.com

SINGAPORE

51 Newton Road,
#15-08/10 Goldhill Plaza,
Singapore, 308900
Phone: +65-6358-2160
Fax: +65-6358-2015
e-mail: singaporesales@powerint.com

APPLICATIONS HOTLINE

World Wide +1-408-414-9660

APPLICATIONS FAX

World Wide +1-408-414-9760



Power Integrations

Tel: +1 408 414 9200 Fax: +1 408 414 9201
www.powerint.com