Design Example Report

Title	<i>118 W High Line Input Non-PFC CV/CC Flyback Charger Supply Using TOPSwitch™-JX TOP267EG</i>
Specification	180 VAC – 264 VAC Input; 59 V, 2.0 A Main Output
Application	Battery Charger
Author	Applications Engineering Department
Document Number	DER-580
Date	September 19, 2017
Revision	1.2

Summary and Features

- High power flyback design with low component count
- 180 VAC to 264 VAC universal input (no PFC)
- 66 kHz operation for high efficiency
- High full load efficiency (90% at 230 V)
- Wide output range 59 V, 1.5 V
- Thermal foldback enables no-fan operation

PATENT INFORMATION

The products and applications illustrated herein (including transformer construction and circuits external to the products) may be covered by one or more U.S. and foreign patents, or potentially by pending U.S. and foreign patent applications assigned to Power Integrations. A complete list of Power Integrations' patents may be found at www.powerint.com. Power Integrations grants its customers a license under certain patent rights as set forth at <http://www.powerint.com/ip.htm>.

Table of Contents

1	Introduction	4
2	Power Supply Specification	8
3	Schematic	9
4	Circuit Description	10
4.1	General Topology	10
4.2	EMI Filtering / Rectification	10
4.3	Main Flyback Converter	10
4.4	Output Rectification	11
4.5	Output Current and Voltage Control	11
5	PCB Layout.....	12
6	Bill of Materials	14
7	Magnetics.....	16
7.1	Transformer (T1) Specification	16
7.1.1	Electrical Diagram	16
7.1.2	Electrical Specifications.....	16
7.1.3	Material List.....	16
7.1.4	Build Diagram.....	17
7.1.5	Winding Instructions	17
7.1.6	Winding Illustrations	18
8	Transformer Design Spreadsheet.....	25
9	Heat Sinks.....	29
9.1	Primary Heat Sink.....	29
9.1.1	Primary Heat Sink Sheet Metal	29
9.1.2	Finished Primary Heat Sink	30
9.1.4	Primary Heat Sink Assembly.....	31
10	Performance Data.....	32
10.1	Output Load Considerations for Testing a CV/CC Supply in Battery Charger Applications	32
10.2	Efficiency	33
10.3	No-Load Input Power.....	34
10.4	Main Output V-I Characteristic.....	35
10.4.1	Main Output V-I Characteristic, Constant Resistance Load	35
11	Waveforms.....	36
11.1	Primary Voltage and Current.....	36
11.2	Output Rectifier Peak Reverse Voltage.....	36
11.3	Start-up Output Voltage / Current and Using Constant Current and Constant Voltage Output Loads	37
11.4	Load Transient Response, Voltage Mode 50%-75%-50% Load Step	38
11.5	Output Ripple Measurements.....	39
11.5.1	Ripple Measurement Technique.....	39
11.5.2	Output Ripple Measurements	40



12	Temperature Profiles.....	42
12.1	Temperature Profile at 25 °C Ambient.....	45
12.1.1	180 VAC, 50 Hz, Room Temperature, Open Air 100% Load Overall Temperature Profile.....	47
13	Gain-Phase.....	48
13.1	Main Output Constant Voltage Mode Gain-Phase.....	48
13.2	Main Output Constant Current Mode Gain-Phase.....	49
14	Conducted EMI.....	51
14.1	Conducted EMI Scan.....	52
15	Revision History.....	53

Important Notes:

The output voltage of this supply is close to the SELV limit, so any final application must employ an output connector that prevents consumer contact with output voltage. The transformer does not meet safety standards for creepage, which also makes it imperative to prevent customer access to output voltage. For transformer design options that meet creepage requirements, please contact Power integrations.

1 Introduction

This engineering report describes a 59 V (nominal), 118 W flyback reference design for a power supply operating from 180 VAC to 264 VAC. The power supply output is designed with a constant voltage / constant current characteristic for use in battery charger applications. The charging circuit is optimized for a lead-acid battery. At charging currents below ~ 0.5 A, the output voltage switches from the 59 V charging voltage to a float voltage of 56 V to maintain battery charge without overcharging. This is a standard feature for chargers intended for lead-acid batteries.

The design is based on the TOP267EG with no PFC input stage. It is designed to operate without a fan, with a thermal switch reducing the current limit at elevated temperature (thermal foldback) to enable continued charging at reduced output current without thermal shutdown.



Figure 1 – Photograph, Top View.

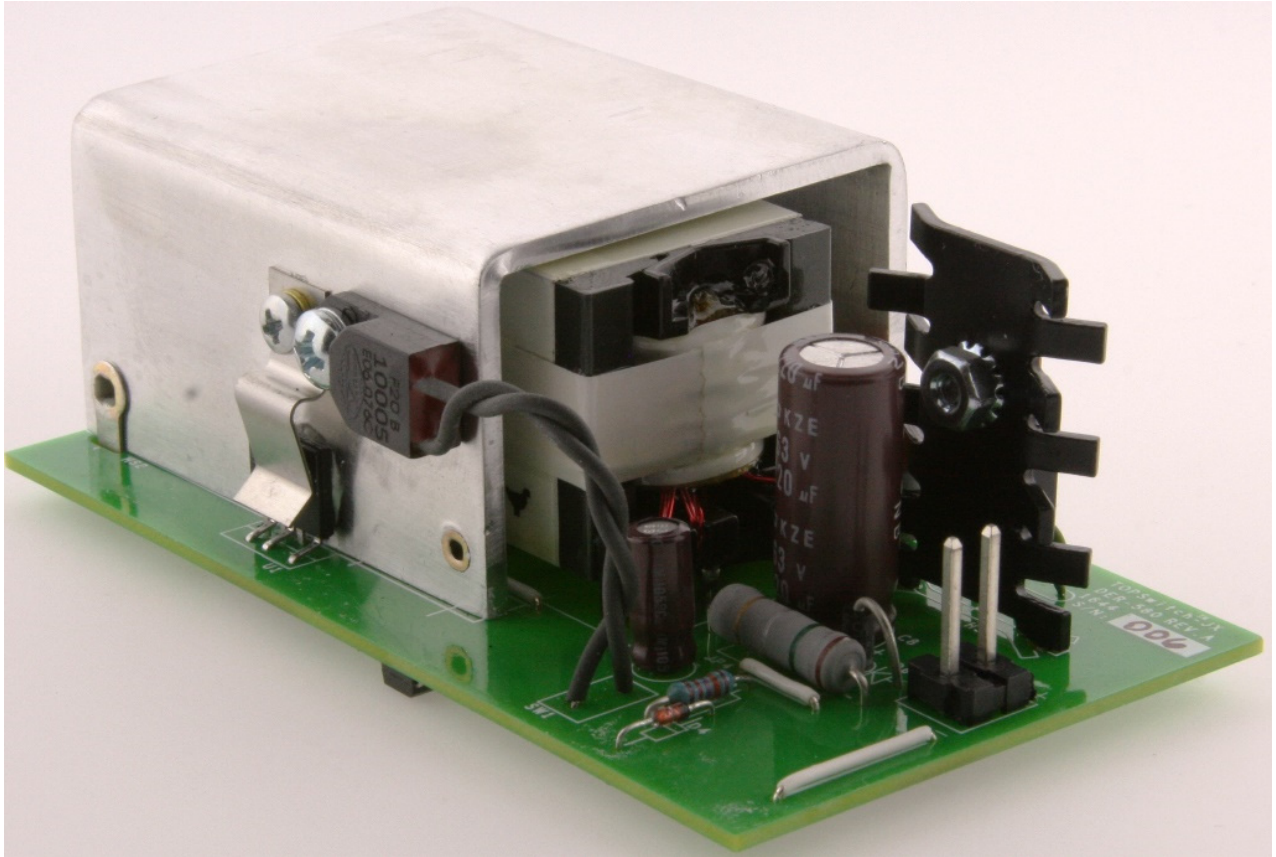

Figure 2 – Photograph, Side View (1).

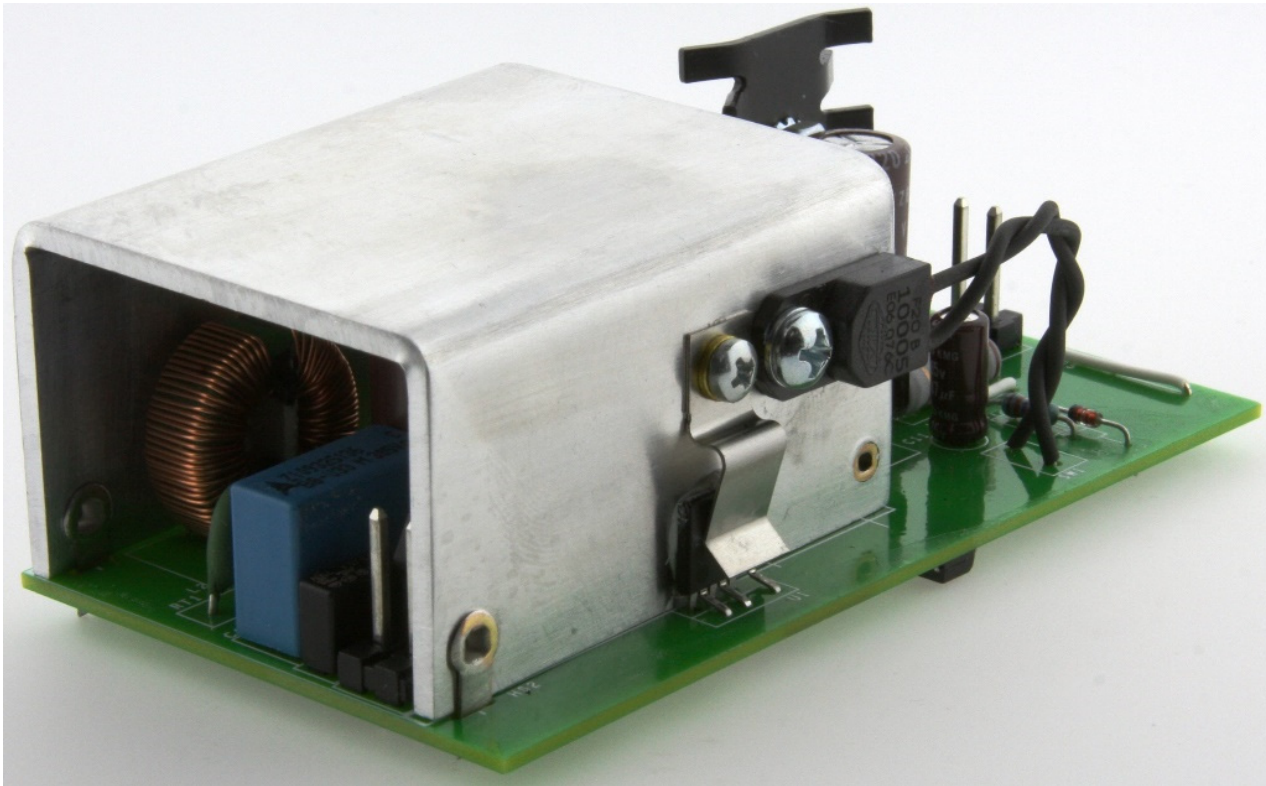

Figure 3 – Photograph, Side View (2).

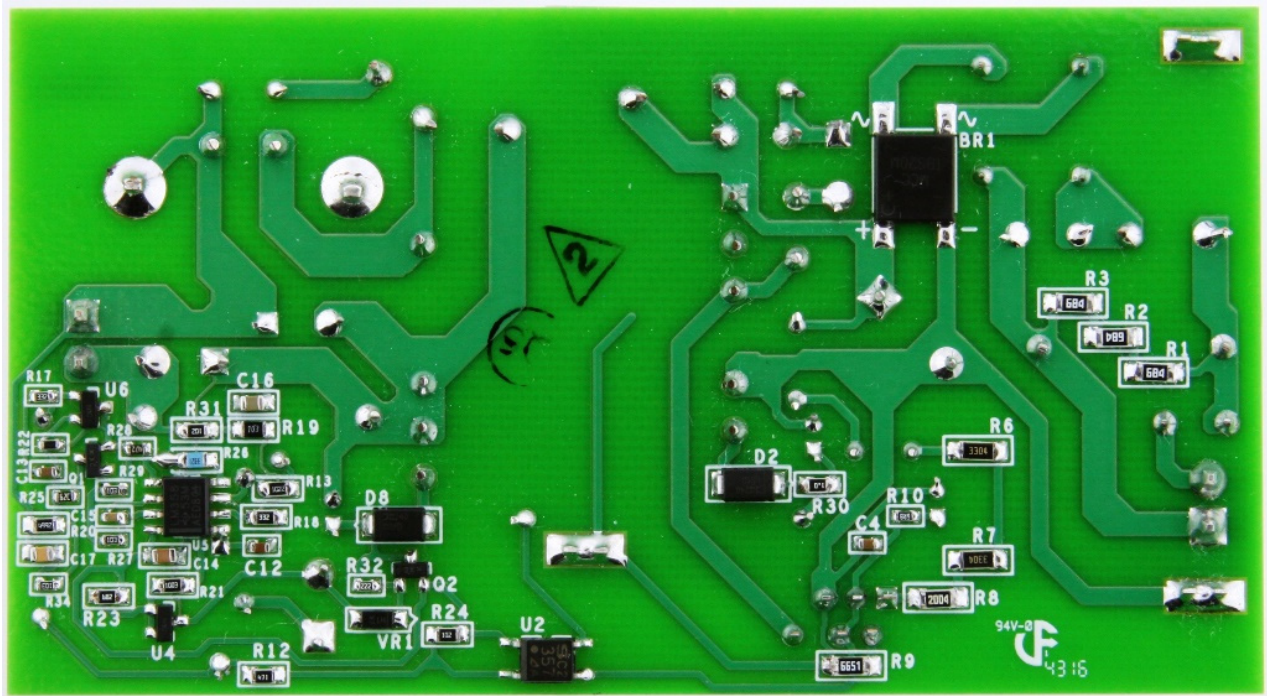

Figure 4 – Photograph, Bottom View.

2 Power Supply Specification

The table below represents the specification for the design detailed in this report. Actual performance is listed in the results section.

Description	Symbol	Min	Typ	Max	Units	Comment
Input						
Voltage	V_{IN}	180		264	VAC	2 Wire Input. Must Operate at 150 VAC.
Frequency	f_{LINE}	47	50/60	64	Hz	
Main Converter Output						
Output Voltage	V_{OUT}	1.5		59	V	59 VDC (Nominal – Otherwise Defined by Battery Load). Nominal Current Limit Setting for Design.
Output Current	I_{OUT}		2.0		A	
Total Output Power						
Continuous Output Power	P_{OUT}		118		W	
Peak Output Power	$P_{OUT(PK)}$			N/A	W	
Efficiency						
Total system at Full Load	η_{Main}		90		%	Measured at 230 VAC, Full Load.
Environmental						
Conducted EMI						
Safety						
Ambient Temperature	T_{AMB}	0	25	65	°C	Fan Cooling, No Shutdown at 180 VAC, 65 °C Ambient, Max Load.

4 Circuit Description

4.1 General Topology

The schematic in Figure 5 shows a 59 V, 118 W high line input flyback power supply utilizing the TOP267EG. The secondary control circuitry provides CV/CC control for use in battery charger applications. The supply is designed to operate without a fan, and switches to a lower output current limit at elevated ambient temperatures to avoid thermal shutdown.

4.2 EMI Filtering / Rectification

Capacitor C1 is used to control differential mode noise. Resistors R1-3 discharge C1 when AC power is removed. Inductor L2 primarily controls common mode EMI, and to some extent, differential mode EMI. The heat sink for U1 is connected to primary return to eliminate the heat sink as a source of radiated/capacitive coupled noise. Thermistor RT1 provides inrush limiting. Capacitor C7 filters common mode EMI. Capacitor C2 and BR1 provide a ~252-370 VDC B+ supply from the 180 VAC to 264 VAC input.

4.3 Main Flyback Converter

The schematic in Figure 5 depicts a 59 V, 118 W flyback DC-DC converter with constant voltage/ constant current output implemented using the TOP267EG. For greater detail on TOPSwitch-JX operation, consult the data sheet at www.power.com.

Integrated circuit U1 incorporates the control circuitry, drivers and output power MOSFET necessary for a flyback converter.

Components D1, C3, and R4-5 form a turn-off clamping circuit that limits the peak drain voltage of U1.

Resistors R6-8 set the start-up voltage for U1 at 201 VDC. Resistor R9 scales the U1 current limit to 100% of rated value. The F pin of U1 is connected to the control pin to set the nominal operating frequency to 66 kHz.

Primary bias is provided from a winding on T1, rectified and filtered by D2, R30, and C5. The winding is phased for "forward mode" so that the primary bias voltage does not collapse when the supply is operating in constant current mode with reduced output voltage.

Components C4, C6, and R10 act as bypass, start-up energy storage, and compensation for U1.

4.4 Output Rectification

The output of transformer T1 is rectified and filtered by D7 and C8. Output rectifier D7 is a 400 V ultrafast rectifier. A snubber consisting of R11 and C9 helps limit the peak voltage excursion on the output rectifier. A forward biased winding referred to secondary return is used to power the secondary CVCC circuitry. This winding is rectified and filtered by D8 and C11. Components Q2, R32, and VR1 comprise a simple series-pass regulator to remove the line frequency ripple component from the secondary bias supply and set its voltage to ~ 10 V. This regulation cleans up the output voltage and current ripple by removing line frequency components for the secondary bias. It also removes any influence of the bias supply on gain-phase characteristics in both voltage mode and current mode operation.

4.5 Output Current and Voltage Control

Output current is sensed via resistor R14. This resistor is clamped by diode D6 to avoid damage to the current control circuitry during an output short-circuit. Components R23 and U4 provide a voltage reference for current sense amplifiers U5A and U5B. The reference voltage for current sense amplifier U5A is divided down by R13, R21, and R26. The nominal current limit setting is 2.0 A, as programmed by R13, R14, R21, and R26. The inverting input of U5A is referenced to ground via R19 and R31. Opamp U5A drives optocoupler U2 through D4 and R12. Components R12, R18-19, R31, C12, and C16 are used for frequency compensation of the current loop.

Programmable shunt regulator U6 is used for output constant voltage control when the current limit is not engaged. Resistors R20, R22, and R25 sense the output voltage. Regulator U6 drives optocoupler U2 via R12. Components R12, R17, R34, C13 and C17 affect the frequency compensation of the voltage control loop.

Opamp U5B is used to sense the output current via R14 and R31, R21, and R26. When the output current falls below 0.5A, opamp U5B acts as a comparator to switch off transistor Q1 via resistor R27 and R29, isolating R25 and causing the output voltage to fall to a "float" voltage of 56 V. Capacitor C15 prevents U5B from oscillating during switching transitions.

Thermal switch SW1 is mounted on the same heat sink as U1, and is normally open during room temperature operation. At high power elevated ambient temperature operation, SW1 closes, grounding resistor R33 and reducing the output current limit from 2 A to 1 A (1/2 power). This allows the supply to continue running/charging at elevated ambient temperature without entering thermal shutdown, albeit at reduced output. The selected thermal switch is normally open, with a nominal trip temperature of 100 °C and a nominal reset temperature of 70 °C.

5 PCB Layout

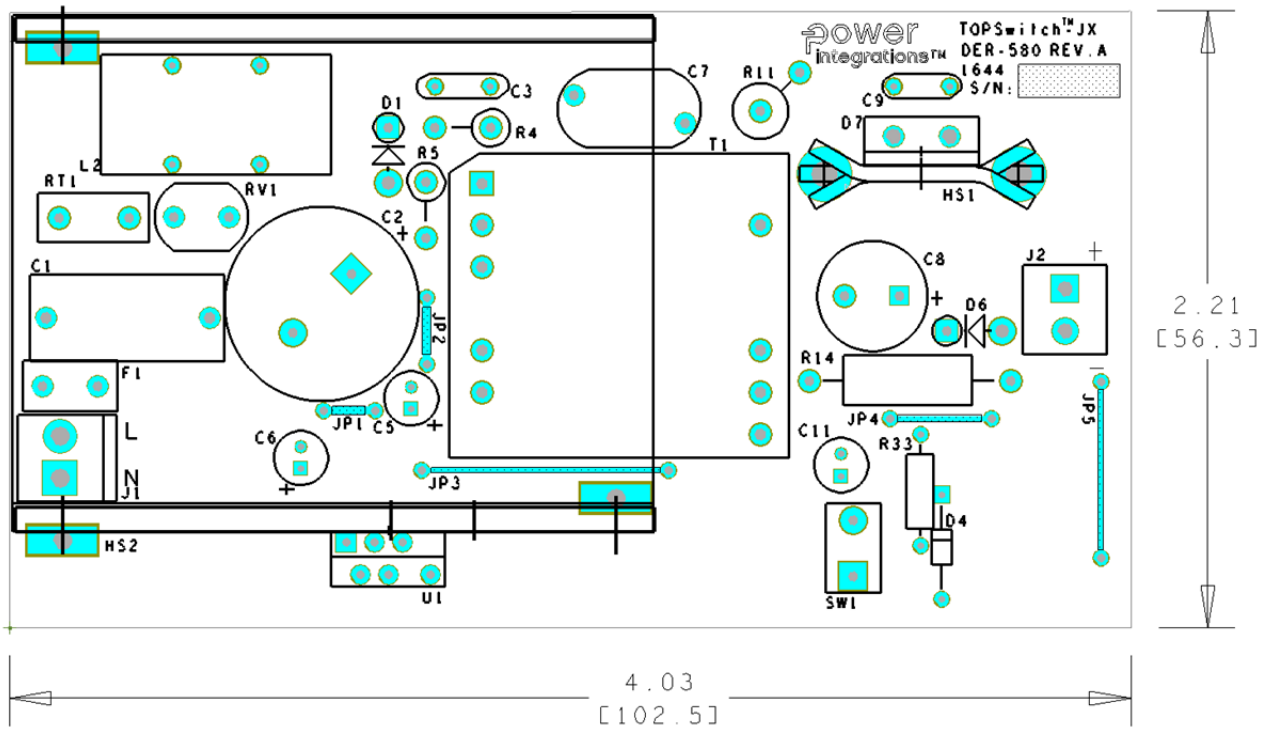

Figure 6 – Printed Circuit Layout, Showing Top Side Components.

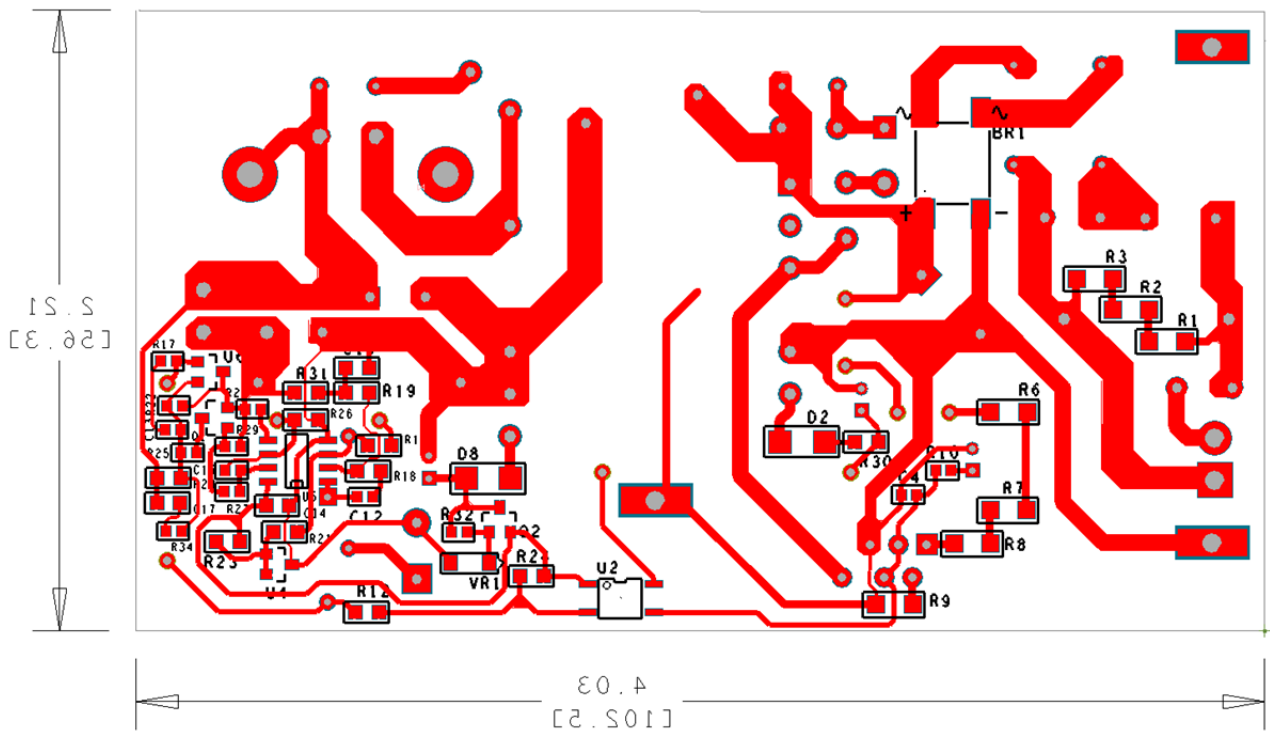

Figure 7 – Printed Circuit Layout, Bottom Side Traces and Components.

6 Bill of Materials

Item	Qty	Ref Des	Description	Mfg Part Number	Mfg
1	1	BR1	BRIDGE RECT, 2A 600 V, TBS-1,	TBS20J-TP	Micro Commercial
2	1	C1	330 nF, 310 VAC, Film, X2	B32922C3334M	Epcos
3	1	C2	82 μ F, 400 V, Electrolytic, (18 x 25)	EKXG401ELL820MM25S	United Chemi-Con
4	1	C3	2.2 nF, 1 kV, Disc Ceramic	NCD222K1KVY5FF	NIC
5	1	C4	100 nF 50 V, Ceramic, X7R, 0603	C1608X7R1H104K	TDK
6	3	C5 C6 C11	47 μ F, 35 V, Electrolytic, Gen. Purpose, (5 x 11)	EKMG350ELL470ME11D	Nippon Chemi-Con
7	1	C7	2.2 nF, Ceramic, Y1	440LD22-R	Vishay
8	1	C8	220 μ F, 63 V, Electrolytic, Gen. Purpose, (10 x 25)	EKZE630ELL221MJ25S	United Chemi-con
9	1	C9	220 pF, 1 kV, Disc Ceramic	NCD221K1KVY5FF	NIC
10	1	C12	220 nF 50 V, Ceramic, X7R, 0603	CGA3E3X7R1H224K	TDK
11	1	C13	330 nF, 16 V, Ceramic, X7R, 0603	C1608X7R1C334K080AC	TDK
12	1	C14	1 μ F, 50 V, Ceramic, X7R, 0805	C2012X7R1H105M	TDK
13	1	C15	47 nF 25 V, Ceramic, X7R, 0603	CC0603KRX7R8BB473	Yageo
14	1	C16	100 nF, 50 V, Ceramic, X7R, 0805	CC0805KRX7R9BB104	Yageo
15	1	C17	4.7 nF, 200 V, Ceramic, X7R, 0805	08052C472KAT2A	AVX
16	1	D1	1000 V, 1 A, Fast Recovery Diode, DO-41	FR107-B	Rectron
17	2	D2 D8	Diode Ultrafast, SW, 200 V, 1 A, SMA	US1D-13-F	Diodes, Inc.
18	1	D4	75 V, 300 mA, Fast Switching, DO-35	1N4148TR	Vishay
19	1	D6	Diode, GEN PURP, 50V, 1A, DO204AL	1N4001-E3/54	Vishay
20	1	D7	400 V, 8 A, Ultrafast Recovery, 35 ns, TO-220AC	MUR840G	ON Semi
21	1	ESIPCLIP M4 METAL1	Heat Sink Hardware, Edge Clip, 20.76 mm L x 8 mm W x 0.015 mm Thk	NP975864	Aavid Thermalloy
22	1	F1	3.15 A, 250V, Slow, RST	507-1181	Belfuse
23	1	HS1	Heat Sink, TO-220, Copper base, staggered, Vertical	6025DG	Aavid Thermalloy
24	1	HS2	MACH, Heat Sink, DER-580		Custom
25	1	J1	Header, 2 Position (1 x 2), 0.156 pitch, Vertical, friction lock	0026481025	Molex
26	1	J2	2 Position (1 x 2) header, 0.156 pitch, Vertical	26-48-1021	Molex
27	1	JP1	Wire Jumper, Insulated, TFE, #22 AWG, 0.2 in	C2004-12-02	Alpha
28	1	JP2	Wire Jumper, Insulated, TFE, #22 AWG, 0.3 in	C2004-12-02	Alpha
29	1	JP3	Wire Jumper, Insulated, TFE, #22 AWG, 0.9 in	C2004-12-02	Alpha
30	1	JP4	Wire Jumper, Insulated, TFE, #22 AWG, 0.4 in	C2004-12-02	Alpha
31	1	JP5	Wire Jumper, Insulated, TFE, #22 AWG, 0.7 in	C2004-12-02	Alpha
32	1	L2	9 mH, 2A, Common Mode Choke	T18107V-902S P.I. Custom TSD-4010	Fontaine Tech Premier Magnetics
33	1	NUT1	Nut, Hex, Kep 6-32, Zinc Plate	6CKNTZR	Any RoHS Compliant Mfg.
34	2	Q1 Q2	NPN, Small Signal BJT, GP SS, 40 V, 0.6 A, SOT-23	MMBT4401LT1G	Diodes, Inc.
35	3	R1 R2 R3	RES, 680 k Ω , 5%, 1/4 W, Thick Film, 1206	ERJ-8GEYJ684V	Panasonic
36	1	R4	RES, 33 k Ω , 5%, 1 W, Metal Oxide	RSF100JB-33K	Yageo
37	1	R5	RES, 33 Ω , 5%, 1 W, Metal Oxide	RSF100JB-33R	Yageo
38	2	R6 R7	RES, 3.30 M Ω , 1%, 1/4 W, Thick Film, 1206	KTR18EZPF3304	Rohm Semi
39	1	R8	RES, 2.00 M Ω , 1%, 1/4 W, Thick Film, 1206	ERJ-8ENF2004V	Panasonic
40	1	R9	RES, 6.65 k Ω , 1%, 1/4 W, Thick Film, 1206	ERJ-8ENF6651V	Panasonic
41	1	R10	RES, 6.8 Ω , 5%, 1/10 W, Thick Film, 0603	ERJ-3GEYJ6R8V	Panasonic
42	1	R11	RES, 68 Ω , 5%, 1 W, Metal Oxide	RSF100JB-68R	Yageo
43	1	R12	RES, 470 Ω , 5%, 1/8 W, Thick Film, 0805	ERJ-6GEYJ471V	Panasonic
44	1	R13	RES, 10.2 k Ω , 1%, 1/8 W, Thick Film, 0805	ERJ-6ENF1022V	Panasonic
45	1	R14	RES, 0.15 Ω , 5%, 2 W, Metal Oxide	MO200J0R15B	Synton-Tech
46	1	R17	RES, 3.3 k Ω , 5%, 1/10 W, Thick Film, 0603	ERJ-3GEYJ332V	Panasonic



47	1	R18	RES, 3.3 k Ω , 5%, 1/8 W, Thick Film, 0805	ERJ-6GEYJ332V	Panasonic
48	1	R19	RES, 10 k Ω , 5%, 1/8 W, Thick Film, 0805	ERJ-6GEYJ103V	Panasonic
49	1	R20	RES, 49.9 k Ω , 1%, 1/8 W, Thick Film, 0805	ERJ-6ENF4992V	Panasonic
50	1	R21	RES, 100 k Ω , 1%, 1/8 W, Thick Film, 0805	ERJ-6ENF1003V	Panasonic
51	1	R22	RES, 2.32 k Ω , 1%, 1/16 W, Thick Film, 0603	ERJ-3EKF2321V	Panasonic
52	1	R23	RES, 6.8 k Ω , 5%, 1/8 W, Thick Film, 0805	ERJ-6GEYJ682V	Panasonic
53	2	R24 R31	RES, 1 k Ω , 5%, 1/8 W, Thick Film, 0805	ERJ-6GEYJ102V	Panasonic
54	1	R25	RES, 43.2 k Ω , 1%, 1/16 W, Thick Film, 0603	ERJ-3EKF4322V	Panasonic
55	1	R26	RES, 3.32 k Ω , 1%, 1/8 W, Thick Film, 0805	ERJ-6ENF3321V	Panasonic
56	3	R27 R29 R34	RES, 10 k Ω , 5%, 1/10 W, Thick Film, 0603	ERJ-3GEYJ103V	Panasonic
57	1	R28	RES, 4.7 k Ω , 5%, 1/10 W, Thick Film, 0603	ERJ-3GEYJ472V	Panasonic
58	1	R30	RES, 1 Ω , 5%, 1/8 W, Thick Film, 0805	ERJ-6GEYJ1R0V	Panasonic
59	1	R32	RES, 2.2 k Ω , 5%, 1/10 W, Thick Film, 0603	ERJ-3GEYJ222V	Panasonic
60	1	R33	RES, 13.7 k Ω , 1%, 1/4 W, Metal Film	MFR-25FBF-13K7	Yageo
61	1	RT1	TKS Thermistor, 5 Ω , 3 A	SCK08053MSY	Thinking Elect.
62	2	RTV1 RTV2	Thermally conductive Silicone Grease	120-SA	Wakefield
63	1	RV1	320 VAC, 32 J, 7 mm, RADIAL	ERZ-V07D511	Panasonic
64	1	SCREW1	SCREW MACHINE PHIL 4-40 X 1/4 SS	PMSSS 440 0025 PH	Building Fasteners
65	2	SCREW2 SCREW3	SCREW MACHINE PHIL 6-32 X 1/4 SS	PMSSS 632 0025 PH	Building Fasteners
66	1	SW1	Thermostat, NO, close at 100 C, 70 C reset, 2SIP	F20B10005ACFA06E	Cantherm
67	1	T1	Custom Transformer PQ26/25 Bobbin, Vertical, 12 pins	TSD-4011	Premier Magnetics
68	1	U1	TOPSwitch-JX, eSIP-7F	TOP267EG	Power Integrations
69	1	U2	Optocoupler, 80 V, CTR 80-160%, 4-Mini Flat	PC357N1TJ00F	Sharp
70	2	U4 U6	IC, REG ZENER SHUNT ADJ SOT-23	LM431BIM3/NOPB	National Semi
71	1	U5	DUAL Op Amp, Single Supply, SOIC-8	LM358D	Texas Instruments
72	1	VR1	DIODE ZENER 11 V 500 mW SOD123	MMSZ5241B-7-F	Diodes, Inc.
73	1	WASHER1	WASHER FLAT #4 SS	FWSS 004	Building Fasteners
74	2	WASHER2 WASHER3	Washer Flat #6, SS, Zinc Plate, 0.267 OD x 0.143 ID x 0.032 Thk	620-6Z	Olander Co.

7 Magnetics

7.1 Transformer (T1) Specification

7.1.1 Electrical Diagram

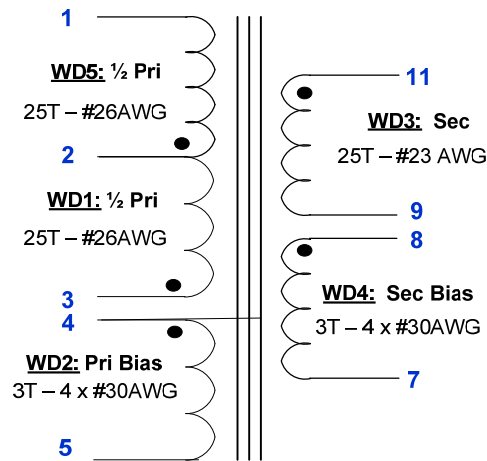

Figure 8 – Transformer Schematic.

7.1.2 Electrical Specifications

Electrical Strength	1 second, 60 Hz, from pins 1-6 to 7-12.	3000 VAC
Primary Inductance	Pins 1-3 all other windings open, measured at 100 kHz, 0.4 V _{RMS} .	673 μH ±10%
Resonant Frequency	Pins 1-3, all other windings open.	1.5 MHz (Min.)
Primary Leakage Inductance	Pins 1-3, with Pins 7-12 shorted, measured at 100·kHz, 0.4 V _{RMS} .	8 μH (Max.)

7.1.3 Material List

Item	Description
[1]	Core Pair PQ26/25: TDK PC44 or equivalent. Gap for A _L of 269 nH/T ² .
[2]	Bobbin: PQ26/25 Vertical, 12 pins, PI Part # 25-00055-00.
[3]	Wire, Magnet Solderable Double Coated, #26 AWG.
[4]	Wire, Magnet Solderable Double Coated, #23 AWG.
[5]	Wire, Magnet, Solderable Double Coated, #30 AWG.
[6]	Tape: Polyester Film, 3M 1350F-1 or Equivalent, 13.5 mm Wide.
[7]	Tape: Polyester Film, 3M 1350F-1 or Equivalent, 10.0 mm Wide.
[8]	Tape: Polyester Web, 3M 44 or Equivalent, 1.5 mm Wide.
[9]	Tape: Copper Foil, 3M 1194 or Equivalent, 8 mm Wide.
[10]	Varnish: Dolph BC-359, or Equivalent.

7.1.4 Build Diagram

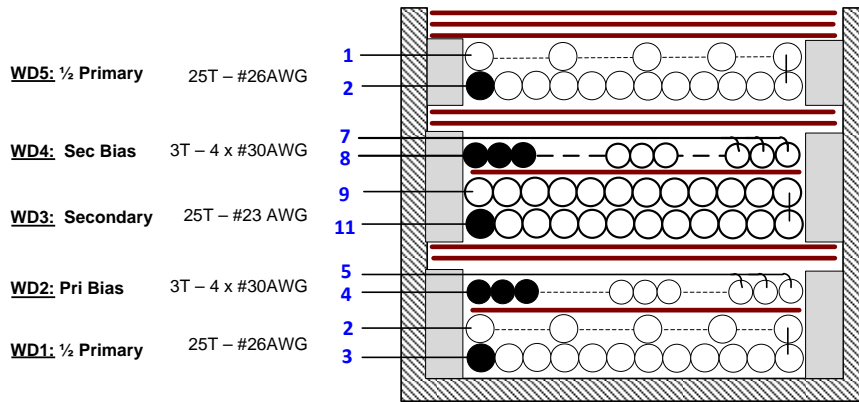

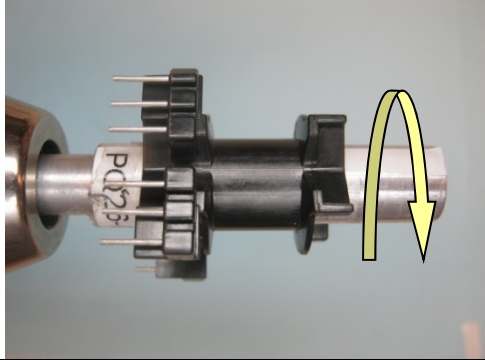

Figure 9 – Transformer Build Diagram.

7.1.5 Winding Instructions

General Note	For the purpose of these instructions, bobbin is oriented on winder such that pins are on the left side (see illustration). Winding direction as shown is clockwise.
Margin	Apply 1.5 mm margin on both sides of bobbin using item [8] match height of first primary and bias winding.
WD1: 1/2 Primary	Starting on pin 3, wind 20 turns of wire item [3] in 1 layer, wind remaining five turns evenly back across bobbin, finish on pin 2.
Insulation	Apply 1 layer of tape item [7].
WD2: Bias	Starting at pin 4, wind 3 quadrifilar turns of wire [5] spaced evenly across bobbin window. Finish on pin 5.
Insulation	Apply 2 layers of tape item [6].
Margin	Apply 1.5 mm margin on both sides of bobbin using item [8] match height of secondary and bias winding.
WD3: Secondary	Starting at pin 11, wind 25 turns of wire item [4] in two layers, finishing at pin 9.
Insulation	Apply 1 layer of tape item [7].
WD4: Secondary Bias	Starting at pin 8, wind 3 quadrifilar turns of wire [5] spaced evenly across bobbin window. Finish on pin 7.
Insulation	Apply 2 layers of tape item [6].
Margin	Apply 1.5 mm margin on both sides of bobbin using item [8] match height of first primary
WD5: 1/2 Primary	Starting on pin 2, wind 20 turns of wire item [3] in 1 layer, wind remaining five turns evenly back across bobbin, finish on pin 1.
Finish Wrap	Apply 3 layers of tape item [6].
Assembly (1)	Assemble gapped and ungapped core halves in bobbin, secure with tape. Using copper tape item [8], apply an outside flux band centered in the bobbin window as shown in illustration. Overlap and solder ends of band to form a shorted turn. Attach wire [5] to copper band and terminate to pin 4.
Assembly (2)	Apply 1 layer of tape item [7] around transformer as shown to insulate flux band. Remove pins 6 and 10, cut pin 2 short. Dip varnish [9].

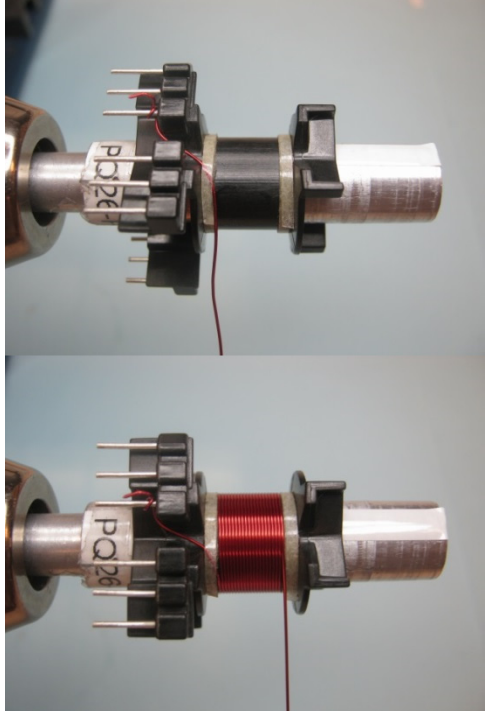

7.1.6 Winding Illustrations

<p>General Note</p>		<p>For the purpose of these instructions, bobbin is oriented on winder such that pins are on the left side (see illustration). Winding direction as shown is clockwise.</p>
<p>Margin</p>		<p>Apply 1.5 mm margin on both sides of bobbin using item [8] match height of first primary and bias winding.</p>
<p>WD1: 1/2 Primary</p>		<p>Starting on pin 3, wind 20 turns of wire item [3] in 1 layer, wind remaining four turns evenly back across bobbin, finish on pin 2.</p>

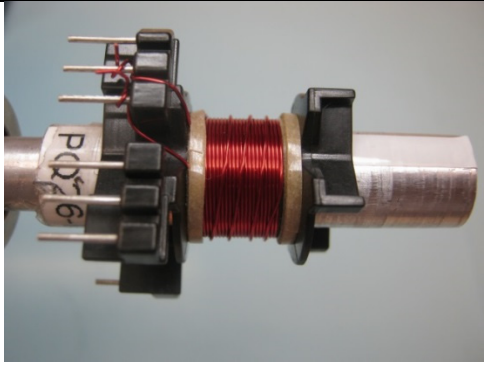
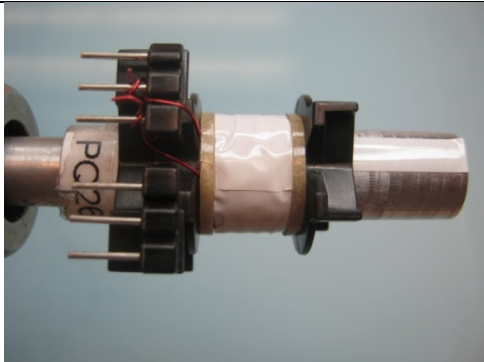
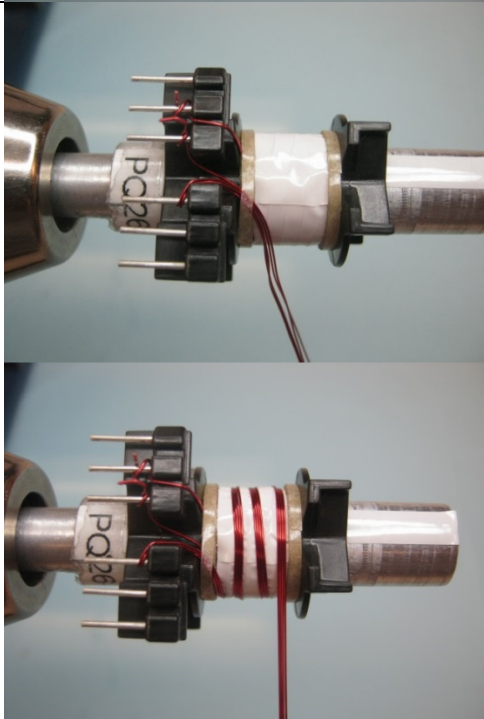
		
<p>Insulation</p>		<p>Apply 1 layer of tape item [7].</p>
<p>WD2: Bias</p>		<p>Starting at pin 4, wind 3 quadrifilar turns of wire item [5] spaced evenly across bobbin window. Finish on pin 5.</p>

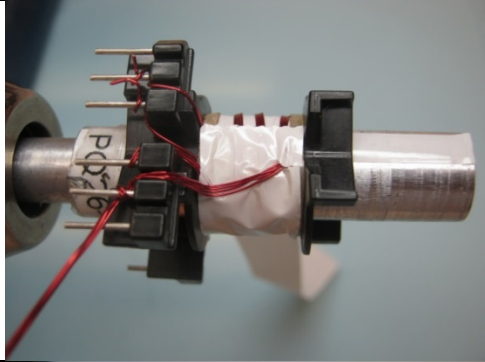
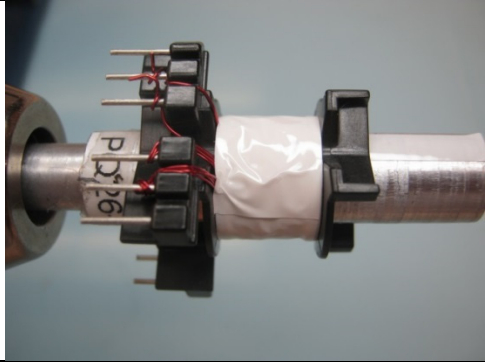
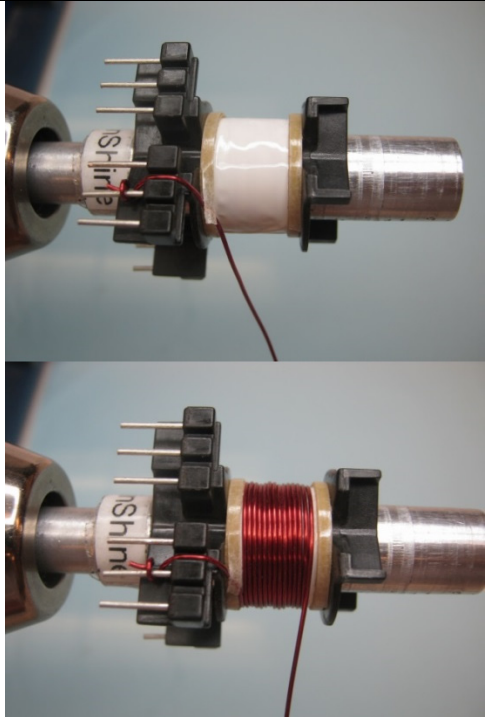
		
<p>Insulation</p>		<p>Apply 2 layers of tape item [6].</p>
<p>WD3: Secondary</p>		<p>Starting at pin 8, wind 3 quad-filar turns of wire item [5] spaced evenly across bobbin window. Finish on pin 7.</p>

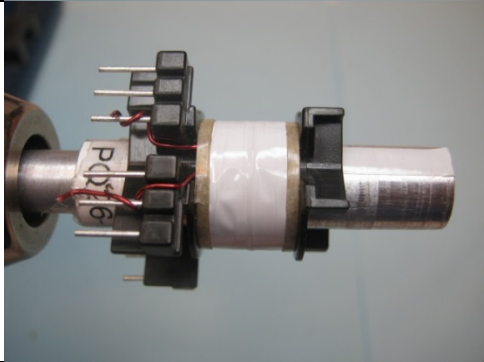
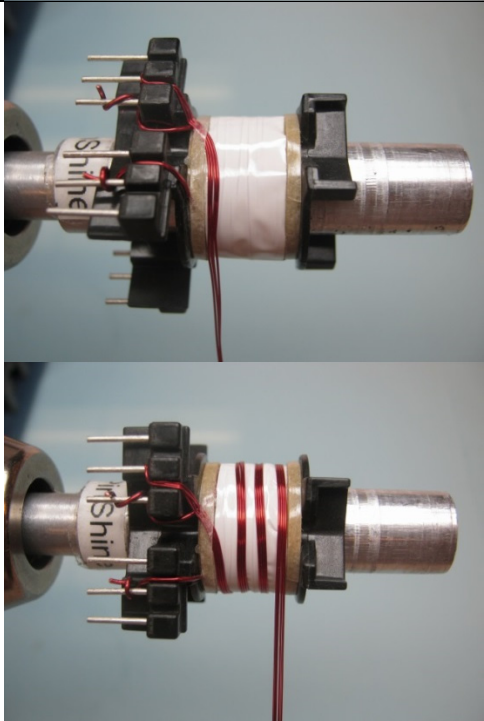
		
<p>Insulation</p>		<p>Apply 1 layer of tape item [7].</p>
<p>WD4: Secondary Bias</p>		<p>Starting at pin 8, wind 3 quadrifilar turns of wire item [5] spaced evenly across bobbin window. Finish on pin 7.</p>

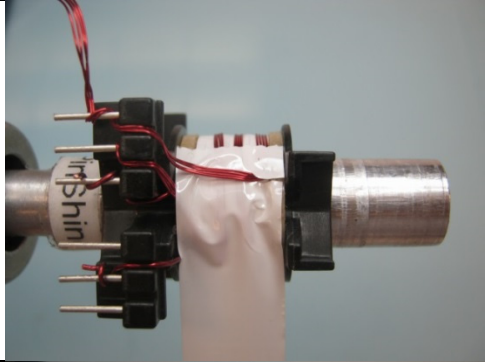
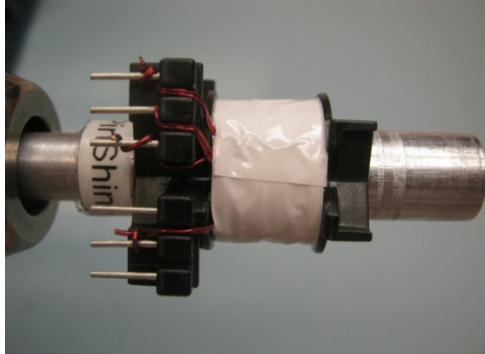
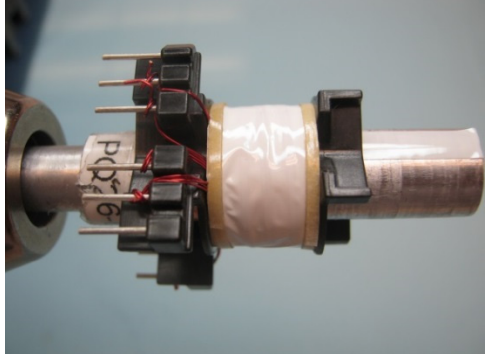
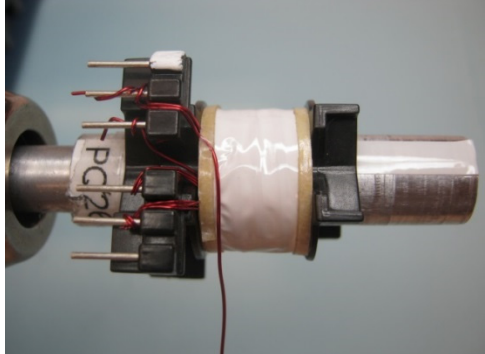
		
<p>Insulation</p>		<p>Apply 2 layers of tape item [6].</p>
		
<p>WD5: 1/2 Primary</p>		<p>Starting on pin 2, wind 20 turns of wire item [3] in 1 layer, wind remaining four turns evenly back across bobbin, finish on pin 1.</p>

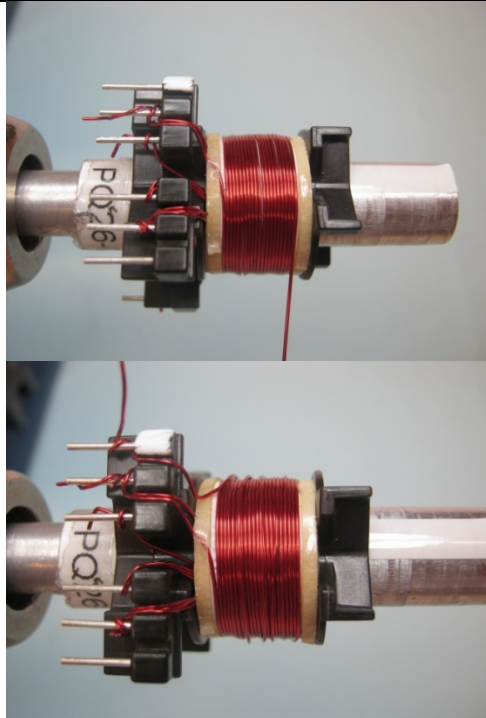
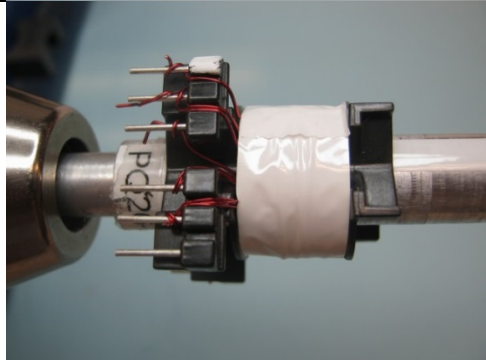
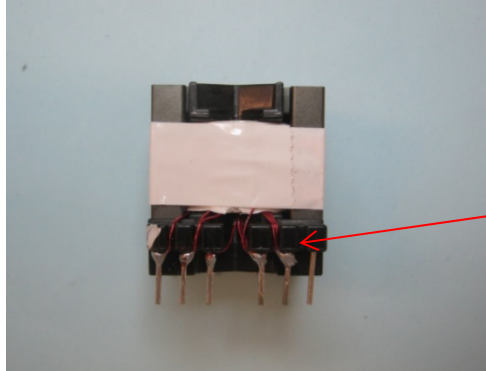
		
<p>Finish Wrap</p>		<p>Apply 3 layers of tape item [6].</p>
<p>Assembly (1)</p>		<p>Assemble gapped and un gapped core halves in bobbin, secure with tape. Using copper tape item [8], apply an outside flux band centered in the bobbin window as shown in illustration. Overlap and solder ends of band to form a shorted turn. Attach wire [5] to copper band and terminate to pin 4.</p>

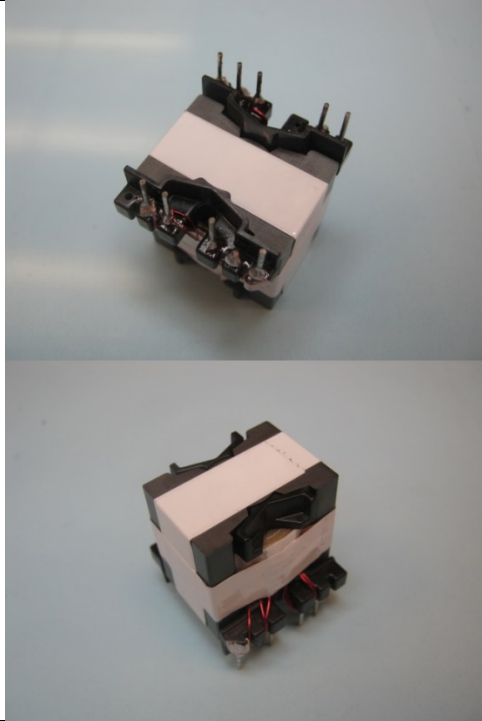
**Assembly
(2)**

Apply 1 layer of tape item [7] around transformer as shown to insulate flux band. Remove pins 6 and 10, cut pin 2 short. Dip varnish item [9].

8 Transformer Design Spreadsheet

ACDC_TOPSwitchJX_032514; Rev.1.6; Copyright Power Integrations 2014	INPUT	INFO	OUTPUT	UNIT	TOP_JX_032514: TOPSwitch-JX Continuous/Discontinuous Flyback Transformer Design Spreadsheet
ENTER APPLICATION VARIABLES					
VACMIN	180			Volts	Minimum AC Input Voltage
VACMAX	265			Volts	Maximum AC Input Voltage
fL	50			Hertz	AC Mains Frequency
VO	59.00			Volts	Output Voltage (main)
PO_AVG	118.00			Watts	Average Output Power
PO_PEAK			118.00	Watts	Peak Output Power
Heatsink Type	External		External		Heatsink Type
Enclosure	Open Frame				Open Frame enclosure assumes sufficient airflow, while Adapter means a sealed enclosure.
n	0.87			%/100	Efficiency Estimate
Z	0.50				Loss allocation factor
VB	12			Volts	Bias Voltage - Verify that VB is > 8 V at no load and VMAX
tC	3.00			ms	Bridge Rectifier Conduction Time Estimate
CIN	82.0		82.0	uFarads	Input Filter Capacitor
ENTER TOPSWITCH-JX VARIABLES					
TOPSwitch-JX	TOP267E			Universal / Peak	115 Doubled/230V
Chosen Device		TOP267E	Power Out	137 W / 137 W	137W
KI	1.00				External Ilimit reduction factor (KI=1.0 for default ILIMIT, KI <1.0 for lower ILIMIT)
ILIMITMIN_EXT			2.800	Amps	Use 1% resistor in setting external ILIMIT
ILIMITMAX_EXT			3.311	Amps	Use 1% resistor in setting external ILIMIT. Includes tolerance over temperature. See Fig 37 of datasheet
Frequency (F)=132kHz, (H)=66kHz	H		H		Select 'H' for Half frequency - 66kHz, or 'F' for Full frequency - 132kHz
fS			66000	Hertz	TOPSwitch-JX Switching Frequency: Choose between 132 kHz and 66 kHz
fSmin			59400	Hertz	TOPSwitch-JX Minimum Switching Frequency
fSmax			72600	Hertz	TOPSwitch-JX Maximum Switching Frequency
High Line Operating Mode			FF		Full Frequency, Jitter enabled
VOR	120.00			Volts	Reflected Output Voltage
VDS			10.00	Volts	TOPSwitch on-state Drain to Source Voltage
VD	0.80			Volts	Output Winding Diode Forward Voltage Drop
VDB	0.70			Volts	Bias Winding Diode Forward Voltage Drop
KP	0.67				Ripple to Peak Current Ratio (0.3 < KRP < 1.0 : 1.0 < KDP < 6.0)
PROTECTION FEATURES					
LINE SENSING					
VUV_STARTUP			201.07	Volts	Minimum DC Bus Voltage at which the power supply will start-up
VOV_SHUTDOWN			1050	Volts	Typical DC Bus Voltage at which power supply will shut-down (Max)
RLS			9.4	M-ohms	Use two standard, 4.7 M-Ohm, 5% resistors in series for line sense functionality.
OUTPUT OVERVOLTAGE					
VZ			22	Volts	Zener Diode rated voltage for Output Overvoltage shutdown protection
RZ			5.1	k-ohms	Output OVP resistor. For latching shutdown use 20 ohm resistor instead
OVERLOAD POWER LIMITING					
X pin functionality					

Overload Current Ratio at VMAX			1.20		Enter the desired margin to current limit at VMAX. A value of 1.2 indicates that the current limit should be 20% higher than peak primary current at VMAX
Overload Current Ratio at VMIN			1.03		Margin to current limit at low line.
ILIMIT_EXT_VMIN			2.62	A	Peak primary Current at VMIN
ILIMIT_EXT_VMAX			2.62	A	Peak Primary Current at VMAX
RIL			6.65	k-ohms	Current limit/Power Limiting resistor.
RPL			N/A	M-ohms	Resistor not required. Use RIL resistor only
ENTER TRANSFORMER CORE/CONSTRUCTION VARIABLES					
Core Type	Custom		PQ26/25		Core Type
Custom Core (Optional)	PQ26/25				If Custom core is used - Enter Part number here
Bobbin		#N/A		P/N:	#N/A
AE	1.2000		1.2000	cm ²	Core Effective Cross Sectional Area
LE	5.4300		5.4300	cm	Core Effective Path Length
AL	6000.0		6000.0	nH/T ²	Ungapped Core Effective Inductance
BW	13.5		13.5	mm	Bobbin Physical Winding Width
M	1.00			mm	Safety Margin Width (Half the Primary to Secondary Creepage Distance)
L	2.00				Number of Primary Layers
NS	25		25		Number of Secondary Turns
DC INPUT VOLTAGE PARAMETERS					
VMIN			204	Volts	Minimum DC Input Voltage
VMAX			375	Volts	Maximum DC Input Voltage
CURRENT WAVEFORM SHAPE PARAMETERS					
DMAX			0.38		Maximum Duty Cycle (calculated at PO_PEAK)
Iavg			0.66	Amps	Average Primary Current (calculated at average output power)
IP			2.62	Amps	Peak Primary Current (calculated at Peak output power)
IR			1.75	Amps	Primary Ripple Current (calculated at average output power)
IRMS			1.12	Amps	Primary RMS Current (calculated at average output power)
TRANSFORMER PRIMARY DESIGN PARAMETERS					
LP			673	uHenries	Primary Inductance
LP Tolerance			10		Tolerance of Primary Inductance
NP			50		Primary Winding Number of Turns
NB			5		Bias Winding Number of Turns
ALG			268	nH/T ²	Gapped Core Effective Inductance
BM			2926	Gauss	Maximum Flux Density at PO, VMIN (BM<3000)
BP			4073	Gauss	Peak Flux Density (BP<4200) at ILIMITMAX and LP_MAX. Note: Recommended values for adapters and external power supplies <=3600 Gauss
BAC			980	Gauss	AC Flux Density for Core Loss Curves (0.5 X Peak to Peak)
ur			2161		Relative Permeability of Ungapped Core
LG			0.54	mm	Gap Length (Lg > 0.1 mm)
BWE			23	mm	Effective Bobbin Width
OD			0.46	mm	Maximum Primary Wire Diameter including insulation
INS			0.06	mm	Estimated Total Insulation Thickness (= 2 * film thickness)
DIA			0.40	mm	Bare conductor diameter
AWG			27	AWG	Primary Wire Gauge (Rounded to next smaller standard AWG value)
CM			203	Cmils	Bare conductor effective area in circular mils
CMA		Warning	181	Cmils/Amp	!!! INCREASE CMA>200 (increase L(primary layers),decrease NS,larger Core)



Primary Current Density (J)			10.96	Amps/mm ²	!!! Decrease current density Use larger wire diameter, increase L or increase core size.
TRANSFORMER SECONDARY DESIGN PARAMETERS (SINGLE OUTPUT EQUIVALENT)					
Lumped parameters					
ISP			5.25	Amps	Peak Secondary Current
ISRMS			2.86	Amps	Secondary RMS Current
IO_PEAK			2.00	Amps	Secondary Peak Output Current
IO			2.00	Amps	Average Power Supply Output Current
IRIPPLE			2.04	Amps	Output Capacitor RMS Ripple Current
CMS			572	Cmils	Secondary Bare Conductor minimum circular mils
AWGS			22	AWG	Secondary Wire Gauge (Rounded up to next larger standard AWG value)
DIAS			0.65	mm	Secondary Minimum Bare Conductor Diameter
ODS			0.46	mm	Secondary Maximum Outside Diameter for Triple Insulated Wire
INSS			-0.09	mm	Maximum Secondary Insulation Wall Thickness
VOLTAGE STRESS PARAMETERS					
VDRAIN			611	Volts	Maximum Drain Voltage Estimate (Includes Effect of Leakage Inductance)
PIVS			246	Volts	Output Rectifier Maximum Peak Inverse Voltage
PIVB			52	Volts	Bias Rectifier Maximum Peak Inverse Voltage
TRANSFORMER SECONDARY DESIGN PARAMETERS (MULTIPLE OUTPUTS)					
1st output					
VO1			59.00	Volts	Output Voltage
IO1_AVG			2.00	Amps	Average DC Output Current
PO1_AVG			118.00	Watts	Average Output Power
VD1			0.80	Volts	Output Diode Forward Voltage Drop
NS1			25.00		Output Winding Number of Turns
ISRMS1			2.858	Amps	Output Winding RMS Current
IRIPPLE1			2.04	Amps	Output Capacitor RMS Ripple Current
PIVS1			246	Volts	Output Rectifier Maximum Peak Inverse Voltage
CMS1			572	Cmils	Output Winding Bare Conductor minimum circular mils
AWGS1			22	AWG	Wire Gauge (Rounded up to next larger standard AWG value)
DIAS1			0.65	mm	Minimum Bare Conductor Diameter
ODS1			0.46	mm	Maximum Outside Diameter for Triple Insulated Wire
2nd output					
VO2				Volts	Output Voltage
IO2_AVG				Amps	Average DC Output Current
PO2_AVG			0.00	Watts	Average Output Power
VD2			0.70	Volts	Output Diode Forward Voltage Drop
NS2			0.29		Output Winding Number of Turns
ISRMS2			0.000	Amps	Output Winding RMS Current
IRIPPLE2			0.00	Amps	Output Capacitor RMS Ripple Current
PIVS2			2	Volts	Output Rectifier Maximum Peak Inverse Voltage
CMS2			0	Cmils	Output Winding Bare Conductor minimum circular mils
AWGS2			N/A	AWG	Wire Gauge (Rounded up to next larger standard AWG value)
DIAS2			N/A	mm	Minimum Bare Conductor Diameter
ODS2			N/A	mm	Maximum Outside Diameter for Triple Insulated Wire
3rd output					
VO3				Volts	Output Voltage
IO3_AVG				Amps	Average DC Output Current
PO3_AVG			0.00	Watts	Average Output Power
VD3			0.70	Volts	Output Diode Forward Voltage Drop
NS3			0.29		Output Winding Number of Turns

ISRMS3			0.000	Amps	Output Winding RMS Current
IRIPPLE3			0.00	Amps	Output Capacitor RMS Ripple Current
PIVS3			2	Volts	Output Rectifier Maximum Peak Inverse Voltage
CMS3			0	Cmils	Output Winding Bare Conductor minimum circular mils
AWGS3			N/A	AWG	Wire Gauge (Rounded up to next larger standard AWG value)
DIAS3			N/A	mm	Minimum Bare Conductor Diameter
ODS3			N/A	mm	Maximum Outside Diameter for Triple Insulated Wire
Total Continuous Output Power			118	Watts	Total Continuous Output Power
Negative Output	N/A		N/A		If negative output exists enter Output number; e.g.: If VO2 is negative output, enter 2



9 Heat Sinks

9.1 Primary Heat Sink

9.1.1 Primary Heat Sink Sheet Metal

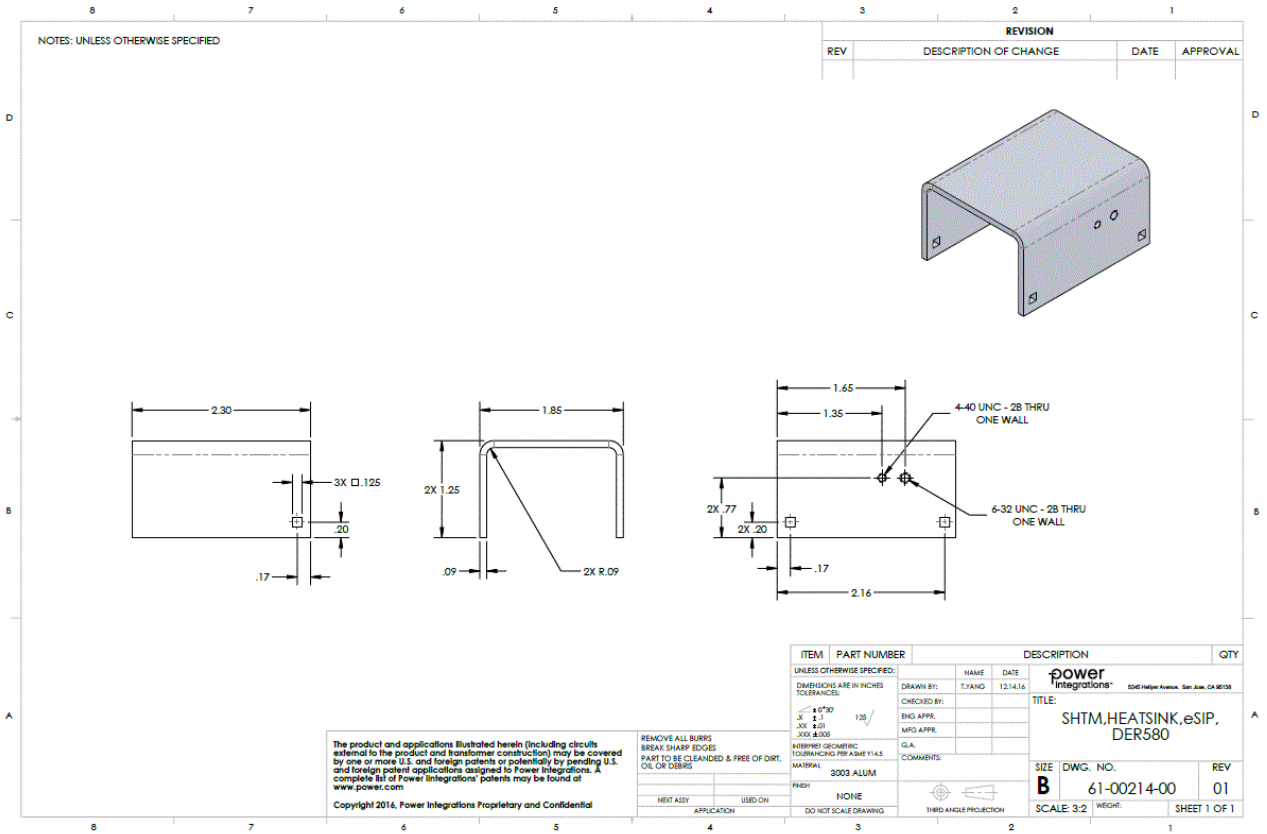

Figure 10 – Primary Heat Sink Sheet Metal.

9.1.2 Finished Primary Heat Sink

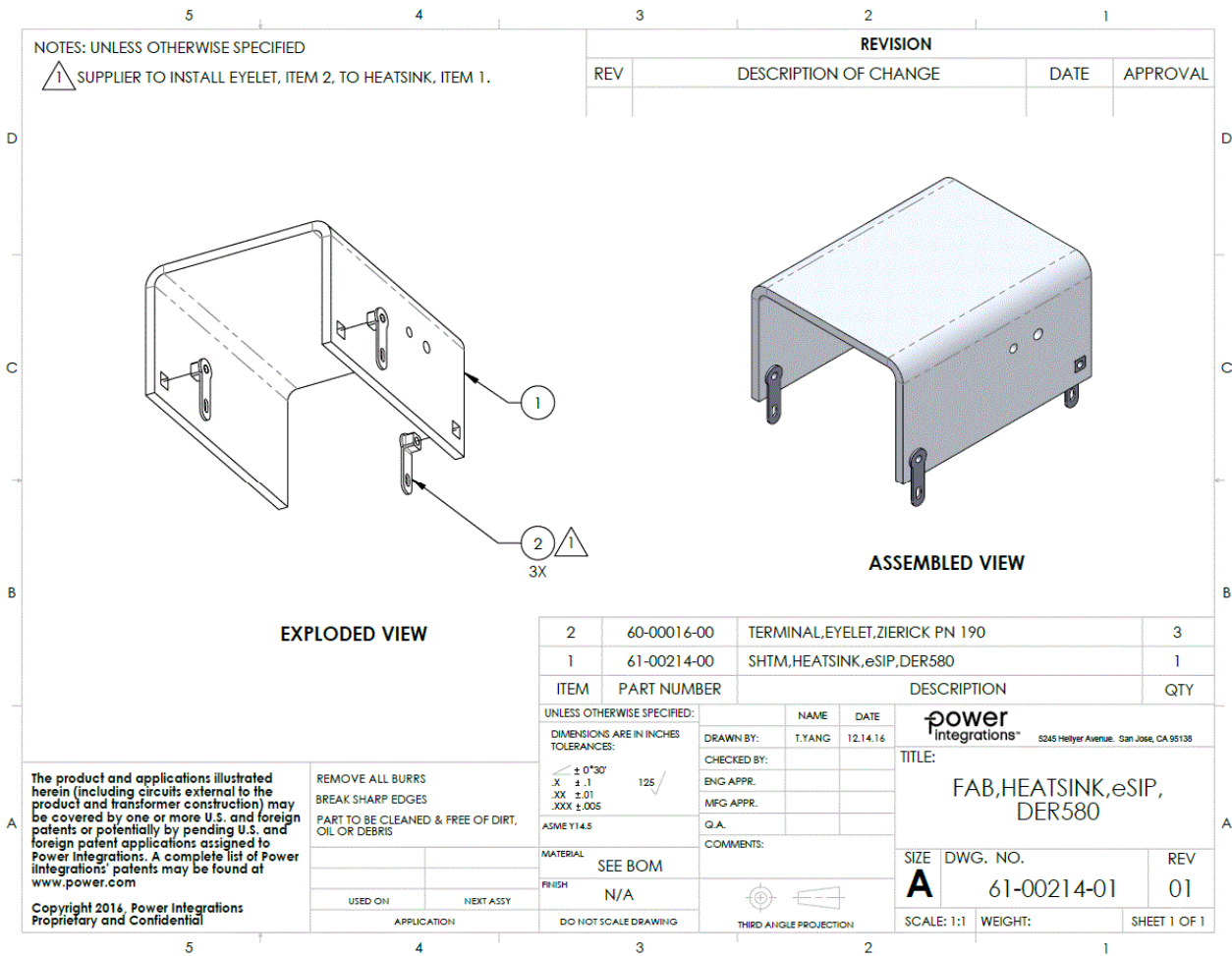

Figure 11 – Finished Primary Heat Sink with Hardware.

10 Performance Data

All measurements were taken at room temperature and 50 Hz (input frequency) unless otherwise specified. Output voltage measurements were taken at the output connectors.

10.1 Output Load Considerations for Testing a CV/CC Supply in Battery Charger Applications

Since this power supply has a constant voltage/constant current output and normally operates in CC mode in its intended application (battery charging), some care must be taken in selecting the type/s of output load for testing.

The default setting for most electronic loads is constant current. This setting can be used in testing a CV/CC supply in the CV portion of its load range below the power supply current limit set point. Once the current limit of the DUT is reached, a constant current load will cause the output voltage of the DUT to immediately collapse to the minimum voltage capability of the electronic load.

To test a CV/CC supply in both its CV and CC regions (an example - obtaining a V-I characteristic curve that spans both the CV and CC regions of operation), an electronic load set for constant resistance can be used. However, in an application where the control loop is strongly affected by the output impedance (such as a battery charger), use of a CR load will give results for loop compensation that are overly optimistic and will likely oscillate when tested with an actual low impedance battery load. For final characterization and tuning the output control loops, a constant voltage load should be used.

Having said this, many electronic loads incorporate a constant voltage setting, but the output impedance of the load in this setting may not be sufficiently low to successfully emulate a real-world battery (impedance on the order of tens of milliohms). Simulating this impedance can be crucial in properly setting the compensation of the current control loop in order to prevent oscillation in a real-life application.

10.2 Efficiency

To make this measurement, the supply was powered with an AC source.

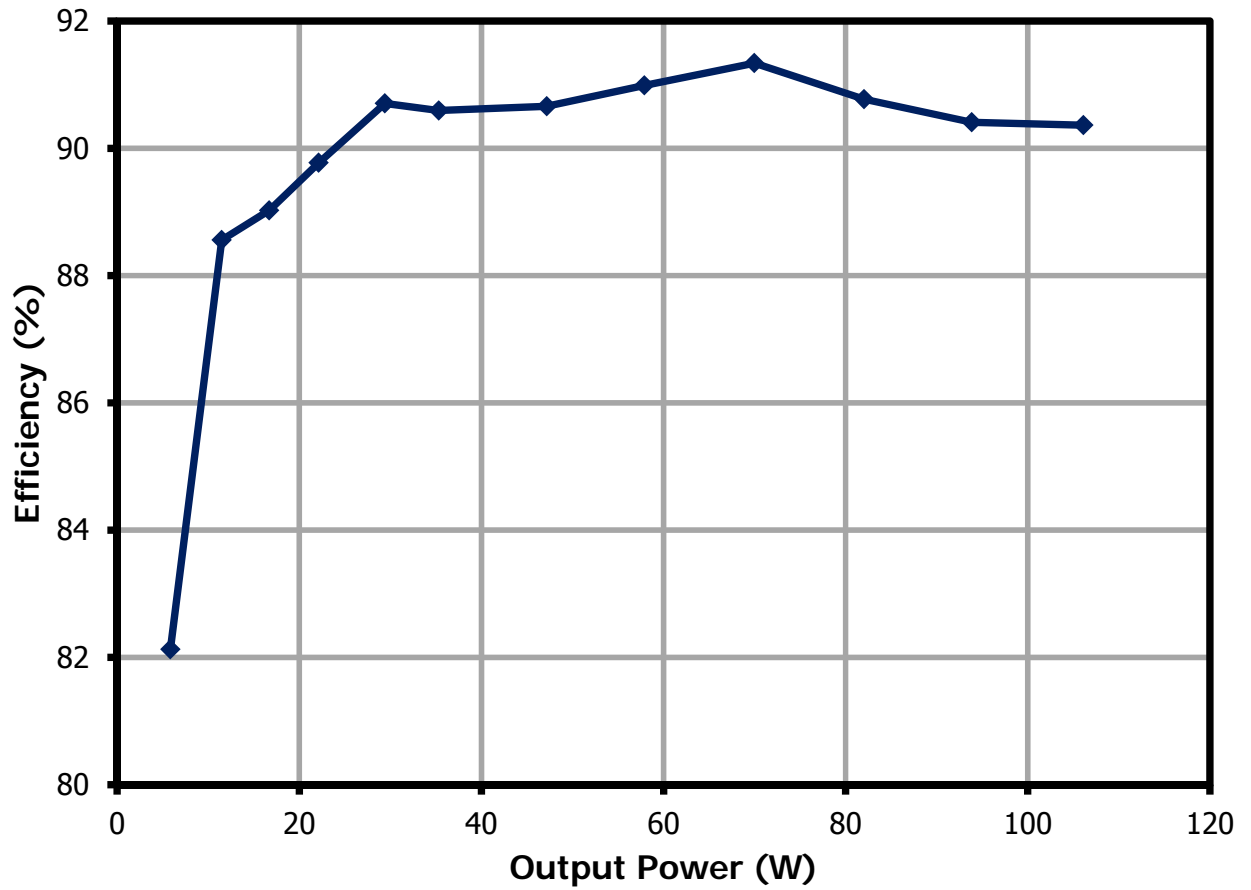

Figure 13 – Efficiency vs. Output Power, 230 VAC Input.



10.3 No-Load Input Power

No-load input power was measured using a Yokogawa WT210 power analyzer. The power meter was set up to record Watt-Hours, with a 20 minute integration time.

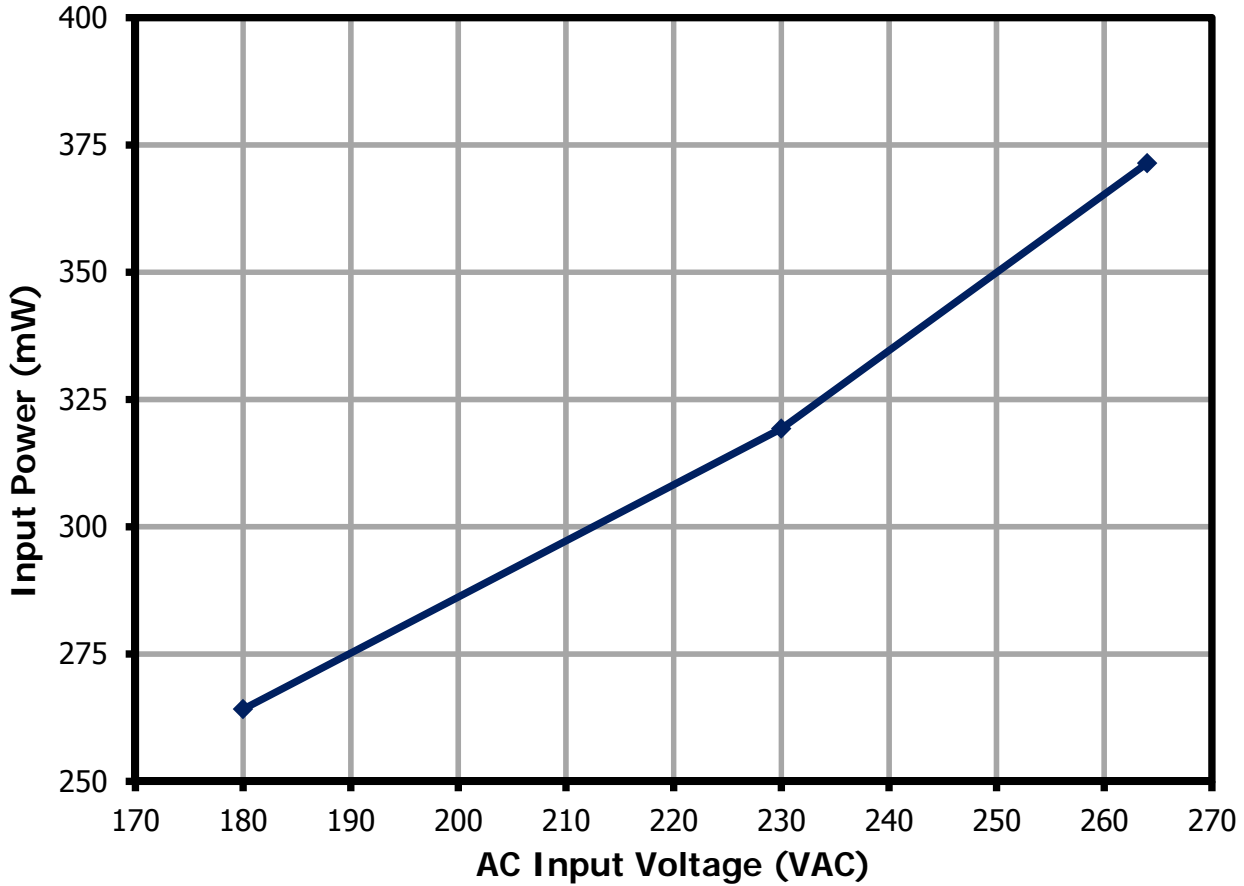

Figure 14 – No-Load Input Power vs. Input Voltage.

10.4 Main Output V-I Characteristic

The main output V-I characteristic showing the transition from constant voltage mode to constant current mode was measured using a Chroma electronic load set for constant resistance. This setting allows proper operation of the DUT in both CV and CC mode. The measurements cut off at ~1.5 VDC, limited by the capabilities of the electronic load. The rise in output voltage at ~0.5 A is caused by the power supply switching from "float" mode (56 V) to "charging" mode (59 V).

10.4.1 Main Output V-I Characteristic, Constant Resistance Load

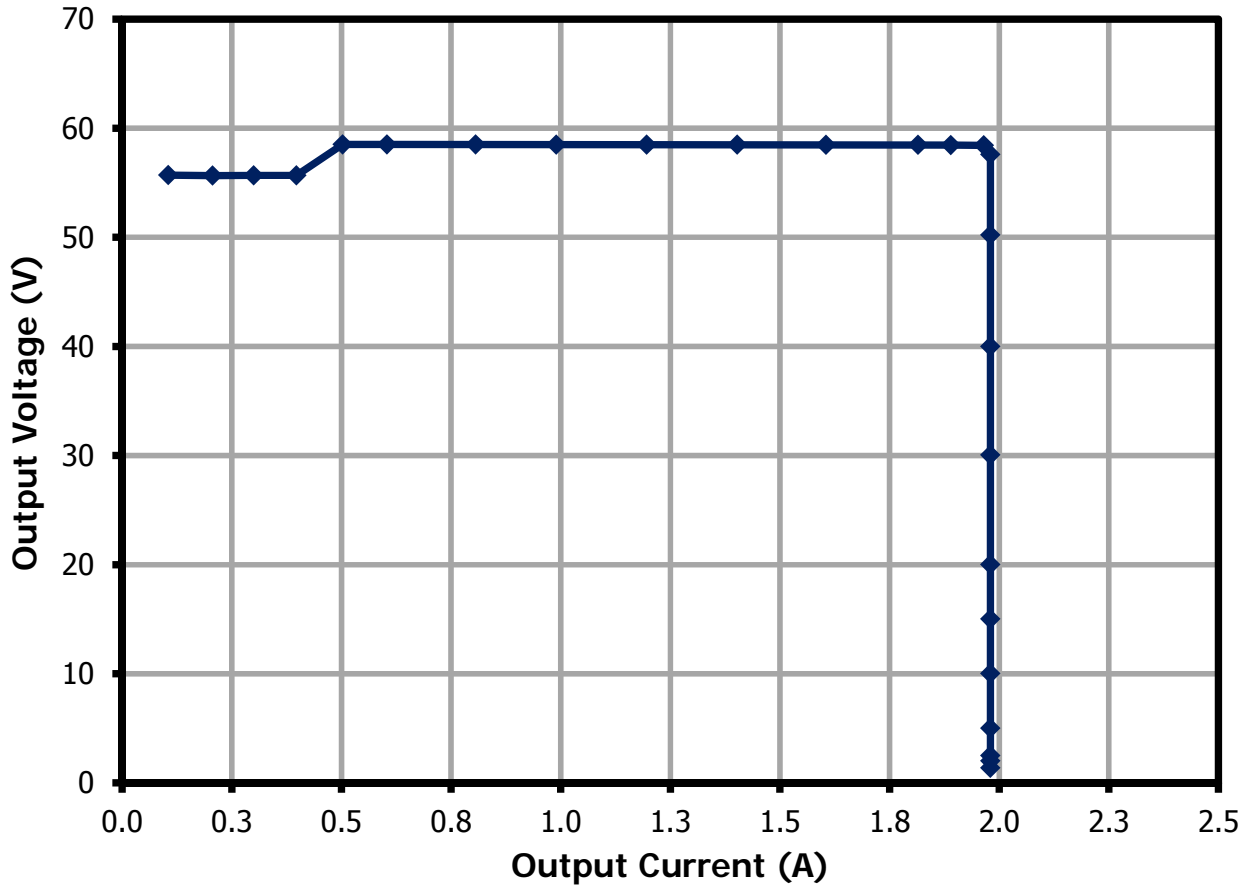

Figure 15 – V-I Characteristic with CR Load.



11 Waveforms

11.1 Primary Voltage and Current

The main stage primary current was measured by inserting a current sensing loop in series with the DRAIN pin of U1.

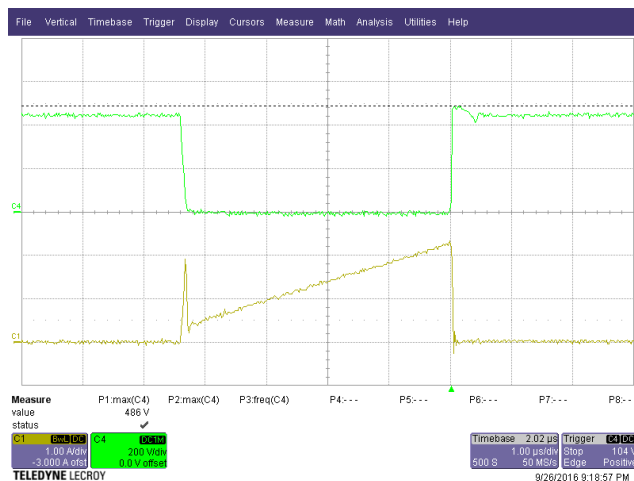

Figure 16 – Primary Voltage and Current, 230 VAC Input, 100% Load.
 Upper: V_{DRAIN} , 200 V / div.
 Lower: I_{DRAIN} , 1 A / div. 1 μ s / div.

11.2 Output Rectifier Peak Reverse Voltage

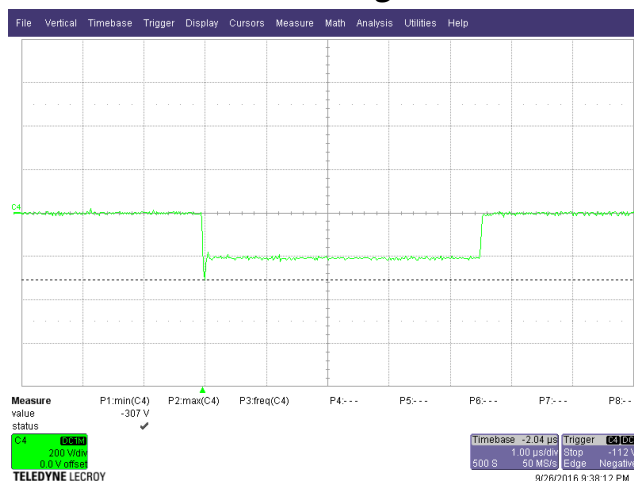

Figure 17 – Output Rectifier (D3) Reverse Voltage, 230 VAC Input, 100% Load.
 200 V, 1 μ s / div.

11.3 Start-up Output Voltage / Current and Using Constant Current and Constant Voltage Output Loads

Figures 16-18 show the power supply output voltage/current start-up profiles. Figure 16 shows the start-up into a constant current load, set to 1.6 A, comfortably below the supply current limit set point. This shows the start-up behavior of the supply in constant voltage mode. Figures 17-18 show the start-up behavior into a constant voltage load, showing the start-up behavior of the supply in constant current mode for two output voltage set points.

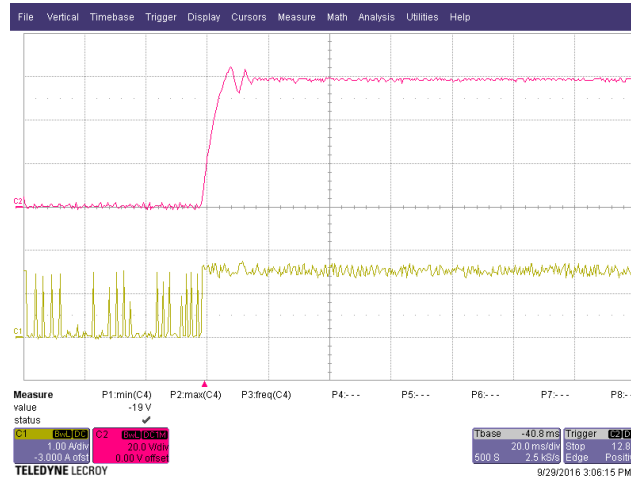

Figure 18 – Output Start-up, CV Mode, 230 VAC, Chroma CC Load, 1.6 A Setting.
Upper: V_{OUT} , 20 V / div.
Lower: I_{OUT} , 1 A, 20 ms / div.

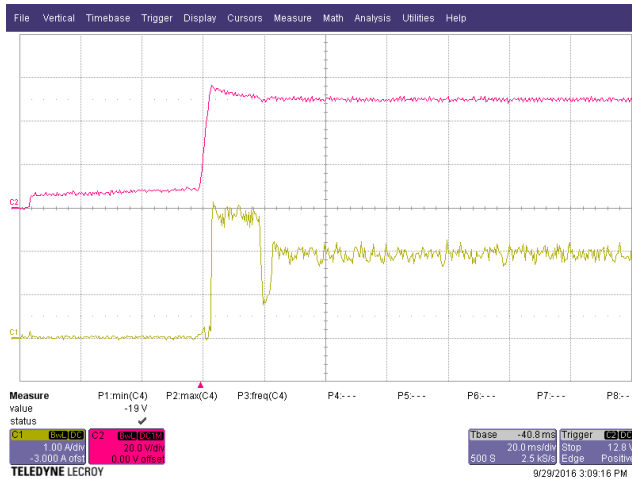

Figure 19 – Output Start-up, CC Mode, 230 VAC, Chroma CV Load, 50 V Setting.
Upper: Main V_{OUT} , 20 V / div.
Lower: Main I_{OUT} , 1 A, 20 ms / div.

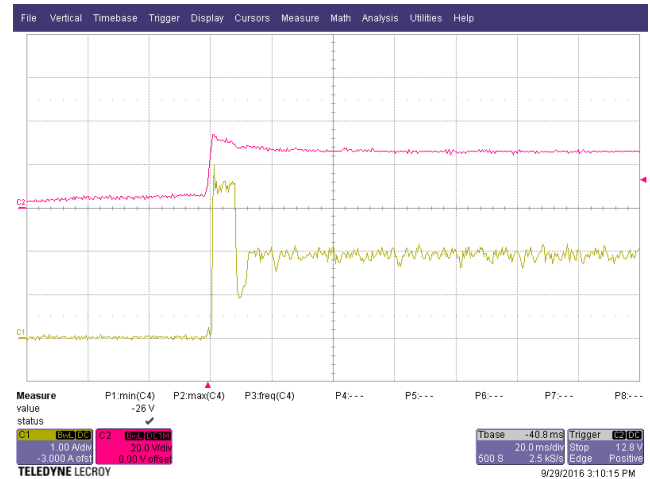

Figure 20 – Output Start-up, CC Mode. 230 VAC, Chroma CV Load, 30 V Setting.
Upper: Main V_{OUT} , 20 V / div.
Lower: Main V_{OUT} 1 A, 20 ms / div.



11.4 Load Transient Response, Voltage Mode 50%-75%-50% Load Step

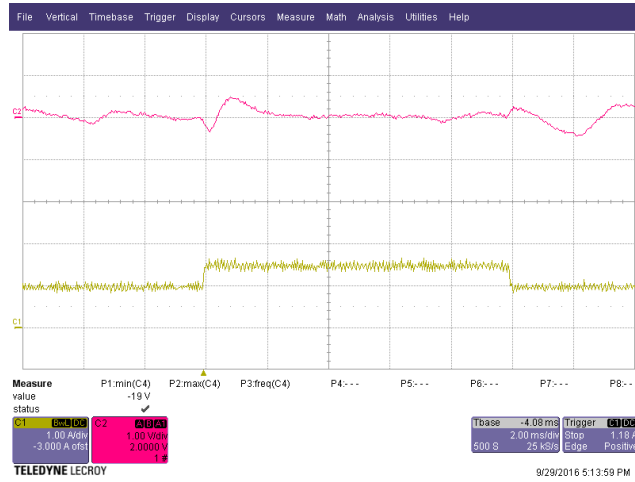

Figure 21 – Output Transient Response, CV Mode, 50%-75%-50% Load Step, 230 VAC Input.
Upper: V_{OUT}, 1 V / div.
Lower: I_{OUT}, 1 A, 2 ms / div.

11.5 Output Ripple Measurements

11.5.1 Ripple Measurement Technique

For DC output ripple measurements a modified oscilloscope test probe is used to reduce spurious signals. Details of the probe modification are provided in the figures below.

Tie two capacitors in parallel across the probe tip of the 4987BA probe adapter. Use a 0.1 μF / 100 V ceramic capacitor and 1.0 μF / 100 V aluminum electrolytic capacitor. The aluminum-electrolytic capacitor is polarized, so always maintain proper polarity across DC outputs.

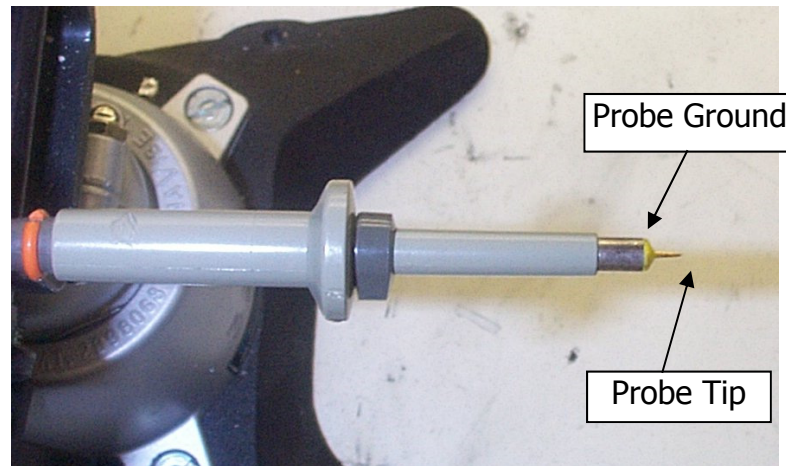

Figure 22 – Oscilloscope Probe Prepared for Ripple Measurement (End Cap and Ground Lead Removed).

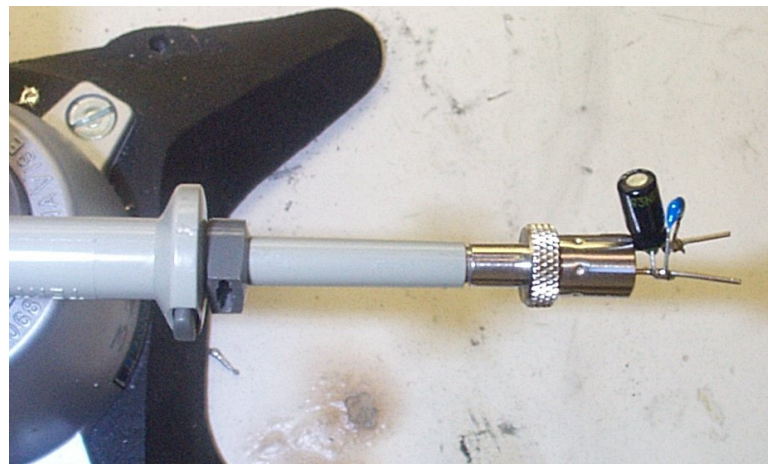

Figure 23 – Oscilloscope Probe with Probe Master 4987BA BNC Adapter (Modified with Wires for Probe Ground for Ripple measurement and Two Parallel Decoupling Capacitors Added).

11.5.2 Output Ripple Measurements

Measurements were taken for output ripple voltage and current with the supply operating in constant voltage mode with a constant current load, and for with the supply operating in CC mode. CC mode measurements were taken using a Chroma electronic load set in CV mode at 50 V and 30 V CV settings. Output ripple voltage/current measurements were made using AC coupled voltage and DC coupled current probes.

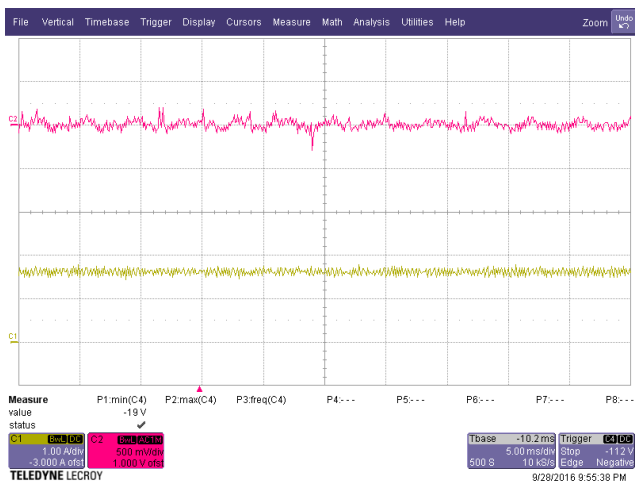

Figure 24 – Main Output Voltage Ripple, 180 VAC, CV Mode, Using Chroma CC Load, 1.5 A Setting.
 Upper: $V_{OUT(RIPPLE)}$, 500 mV / div.
 Lower: $I_{OUT(RIPPLE)}$, 1 A, 5 ms / div.

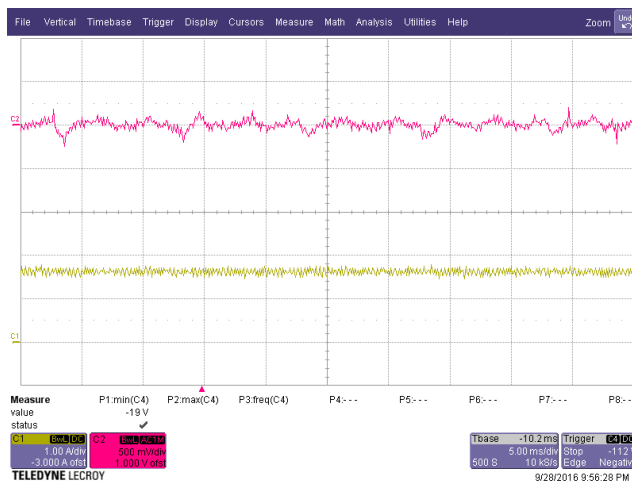

Figure 25 – Output Voltage and Current Ripple in CV Mode, 230 VAC, Chroma CC Load, 1.5 A Setting.
 Upper: $V_{OUT(RIPPLE)}$, 500 mV / div.
 Lower: $I_{OUT(RIPPLE)}$, 1 A, 5 ms / div.

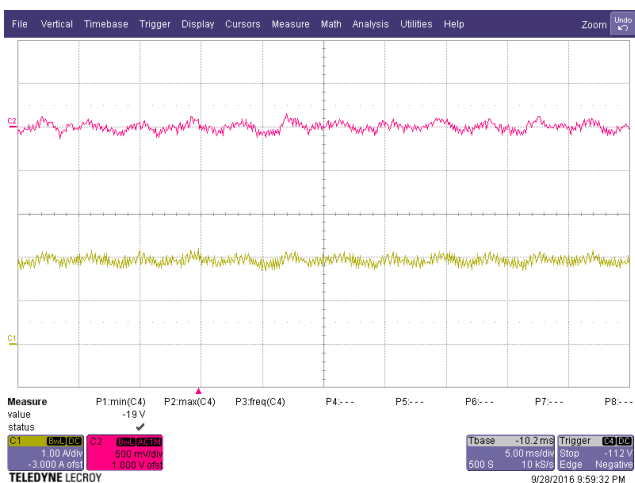

Figure 26 – Main Output Voltage and Current Ripple in CC Mode, 180 VAC, Chroma CV Load, 50 V Setting.
 Upper: Main $V_{OUT(RIPPLE)}$, 500 mV / div.
 Lower: $I_{OUT(RIPPLE)}$, 1 A, 5 ms / div.

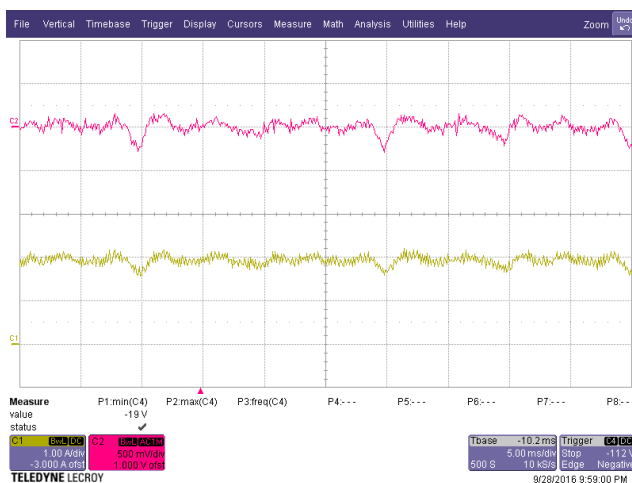

Figure 27 – Main Output Voltage and Current Ripple in CC Mode, 230 VAC, Chroma CV Load, 50 V Setting.
 Upper: Main $V_{OUT(RIPPLE)}$, 500 mV / div.
 Lower: $I_{OUT(RIPPLE)}$, 1 A, 5 ms / div.

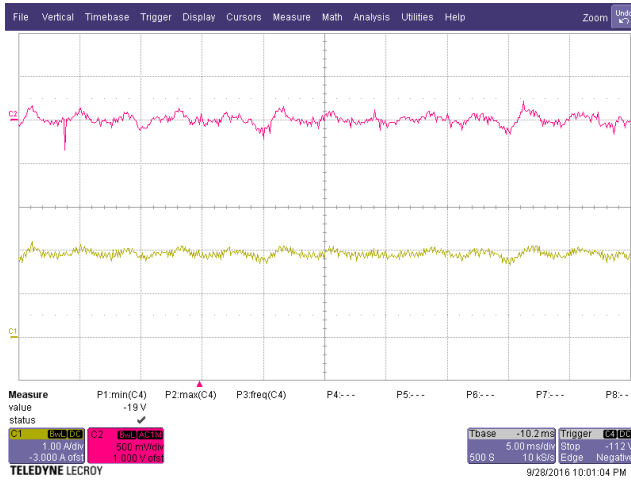

Figure 28 – Main Output Voltage and Current Ripple in CC Mode, 180 VAC, Chroma CV Load, 30 V Setting.
 Upper: Main $V_{OUT(RIPPLE)}$, 500 mV / div.
 Lower: $I_{OUT(RIPPLE)}$, 1 A, 5 ms /div.

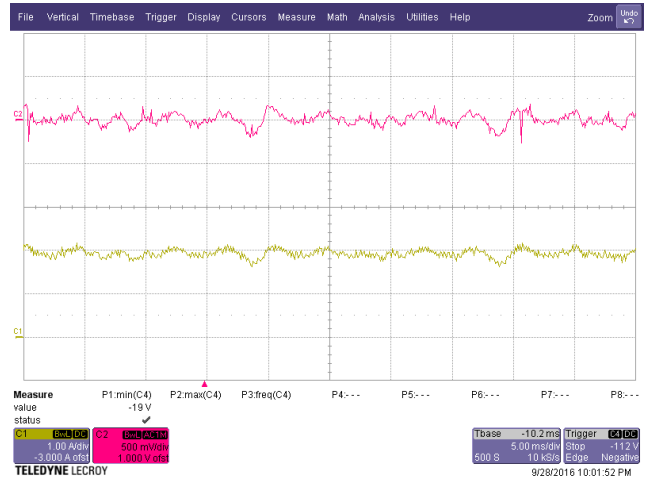

Figure 29 – Main Output Voltage and Current Ripple in CC Mode, 230 VAC, Chroma CV Load, 30 V Setting.
 Upper: Main $V_{OUT(RIPPLE)}$, 500 mV / div.
 Lower: $I_{OUT(RIPPLE)}$, 1 A, 5 ms /div.



12 Temperature Profiles

One particular requirement for this supply was that the unit not shut down at full load, 65 °C ambient. A previous DER circuit (DER-583) utilized a cooling fan. It was the goal of this DER to avoid using a fan, but still allow operation at elevated ambient temperature. One possible solution would be to allow “thermal foldback”, i.e., switching to a lower current limit/lower power at elevated temperatures in order to continue charging without reaching the thermal shutdown temperature of the TOPSwitch (U1).

One simple method of accomplishing this is to use a normally open thermal switch mounted on the primary heat sink adjacent to U1. When activated, it switches in an extra resistor in the current sense amplifier reference divider network (R33) which cuts the current limit by a factor of two. This allows charging to continue (albeit at a lower rate), and either allows the primary heat sink to cool down or keeps it from reaching the U1 thermal shutdown temperature. The thermal switch used in this DER is a Cantherm F20B10005ACFA06E, obtained from a catalog distributor. It is a normally open (NO) switch with a trip temperature of 100 °C nominal, and a nominal reset temperature of 70 °C (30 degrees hysteresis). It has a plastic case designed with a mounting hole for screw attachment next to U1 on the primary heat sink, as well as leads for convenient termination to the power supply PCB. The switch can be seen in Figure 28 below.

For thermal testing, a thermocouple was mounted on this component to monitor the temperature of U1 when the unit is placed in an enclosure for thermal testing. A twisted pair was also soldered on the power supply PCB to monitor the voltage across thermal switch SW1 to monitor whether the power supply was operating in full power (SW1 open) or half power (SW1 closed) mode. When SW1 is open, the voltage across it is ~300 mV, when closed, the voltage is close to zero.

Figure 30 shows the power supply with thermocouple mounted (using thermal epoxy) to measure U1 case temperature.

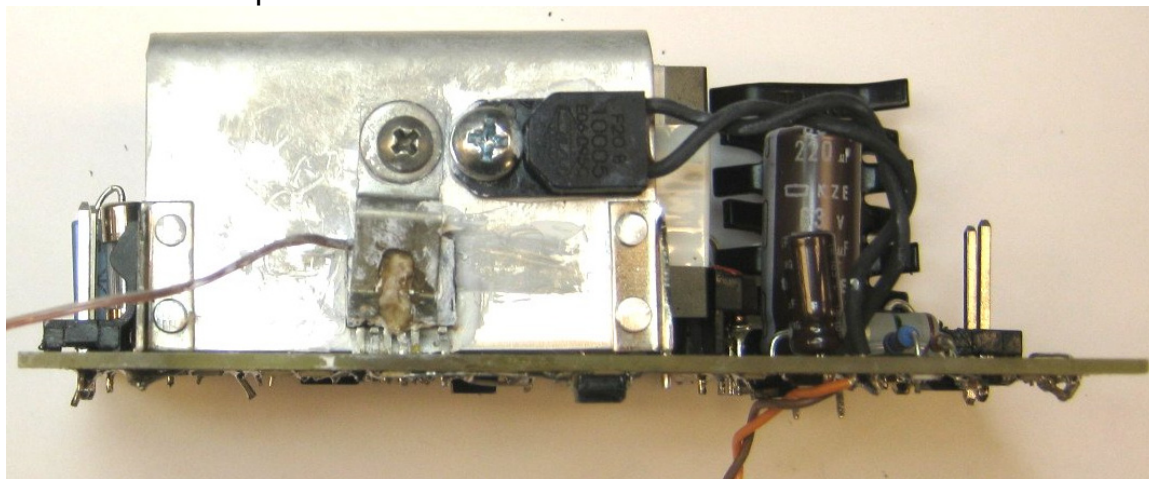

Figure 30 – U1 Thermocouple Placement for Thermal Testing and Thermal Switch (SW1) Position.

Figures 31 and 32 show the supply is placed in an actual customer plastic enclosure. The enclosure was originally fitted with a 40 mm fan. For these tests, the fan is removed, and the fan opening is blocked using tape.

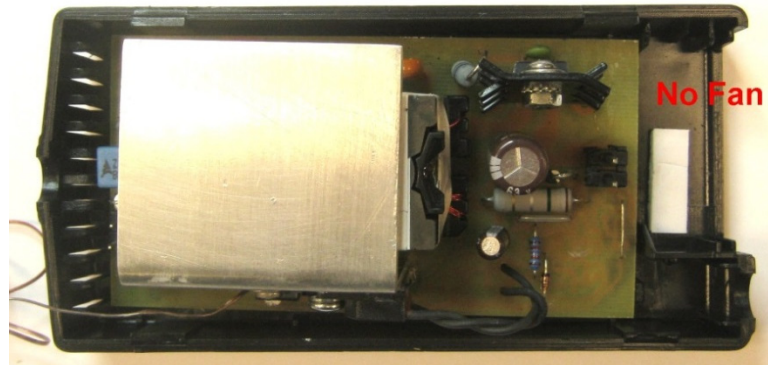

Figure 31 – U1 Enclosure for Thermal Testing, View 1.



Figure 32 – U1 Enclosure for Thermal Testing, View 2.

Figure 33 and 34 show an isolation box used in thermal chamber testing. The box is perforated on four sides (2 are shown) to allow its interior to equilibrate with the thermal chamber environment without direct exposure to the air circulation fan in the thermal chamber. A thermocouple is used to monitor the isolation box interior temperature, and the thermal chamber temperature is adjusted for the desired equilibrium temperature inside the box.



Figure 33 – Isolation Box with Equilibration Holes for Thermal Chamber Testing.



Figure 34 – Isolation Box in Thermal Chamber.

12.1 Temperature Profile at 25 °C Ambient

To generate a thermal profile of the power supply, a Yokogawa MV1000 multichannel data recorder was used. One channel was set up to monitor the voltage across thermal switch SW1, which directly indicates whether the power supply is operating in the high power (2 A current limit) or reduced power (1 A current limit) mode. When SW1 is open the power supply is in high power mode, and the voltage across it is ~300 mV. In reduced power mode, SW1 is closed, and the voltage across it is essentially zero.

A second channel was set up to monitor the case temperature of TOPSwitch U1 via a thermocouple. The operating ambient temperature of the power supply was set to 25 °C. Power supply input voltage was set to 230 V, 50 Hz using a sine wave source, and the supply was loaded with a Kikusui PLZ303WH electronic load set for constant voltage mode, 50 V. This voltage value was a compromise to simulate a partially discharged battery.

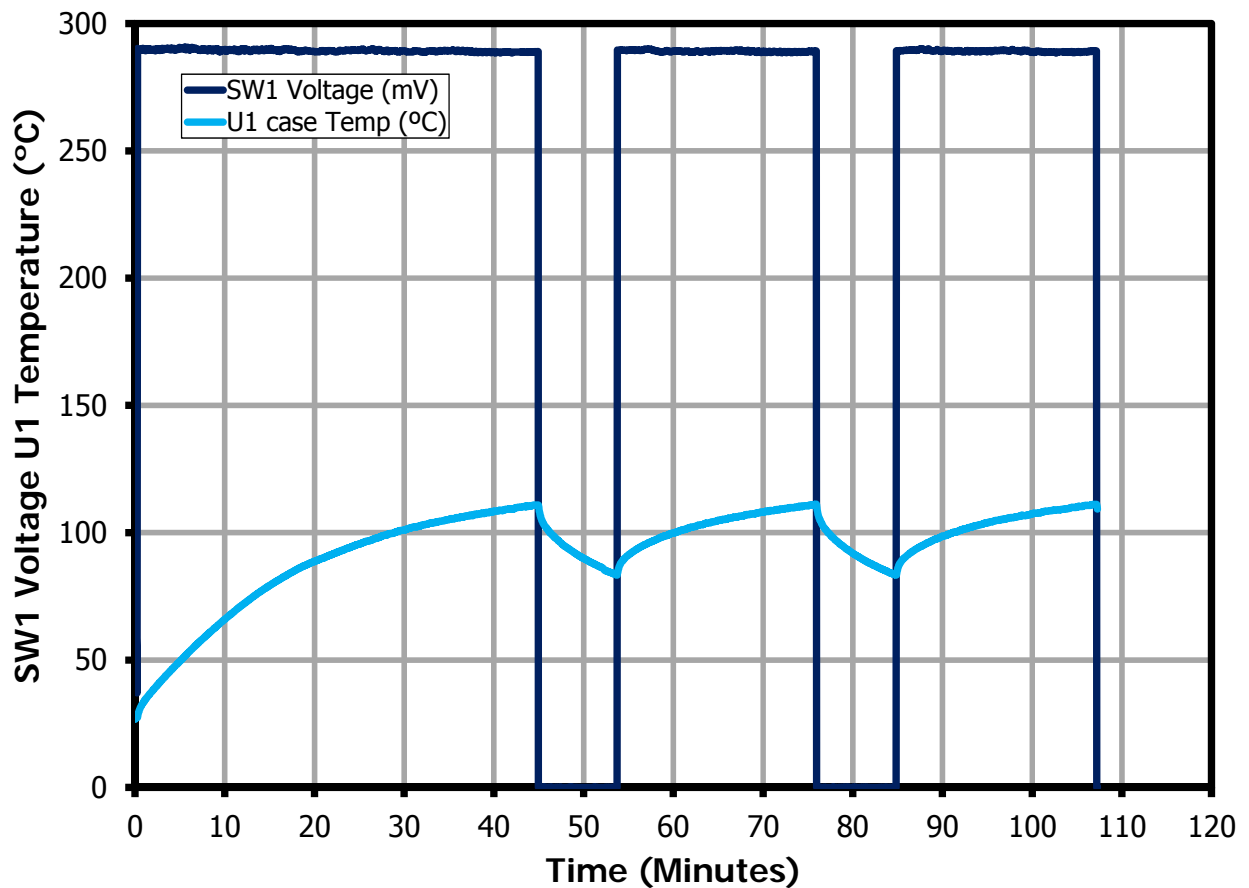

Figure 35 – Thermal Profile for DER-580 Using TOP267EG for U1, 25C Ambient, 230 VAC.



Figure 35 shows the operating profile for a DER-580 using TOP267EG for U1. Starting at 25 °C, the power supply operates at full power for 45 minutes before switching to reduced current limit. This occurs at a U1 case temperature of 111 °C. There is then a cool-down period before thermal switch SW1 resets and power supply again switches to maximum current limit. The supply switches back to full current limit at a U1 case temperature of ~85 °C. Once the power supply reaches thermal equilibrium, it spends ~22.2 minutes at full current limit and 8.9 minutes at reduced current limit.

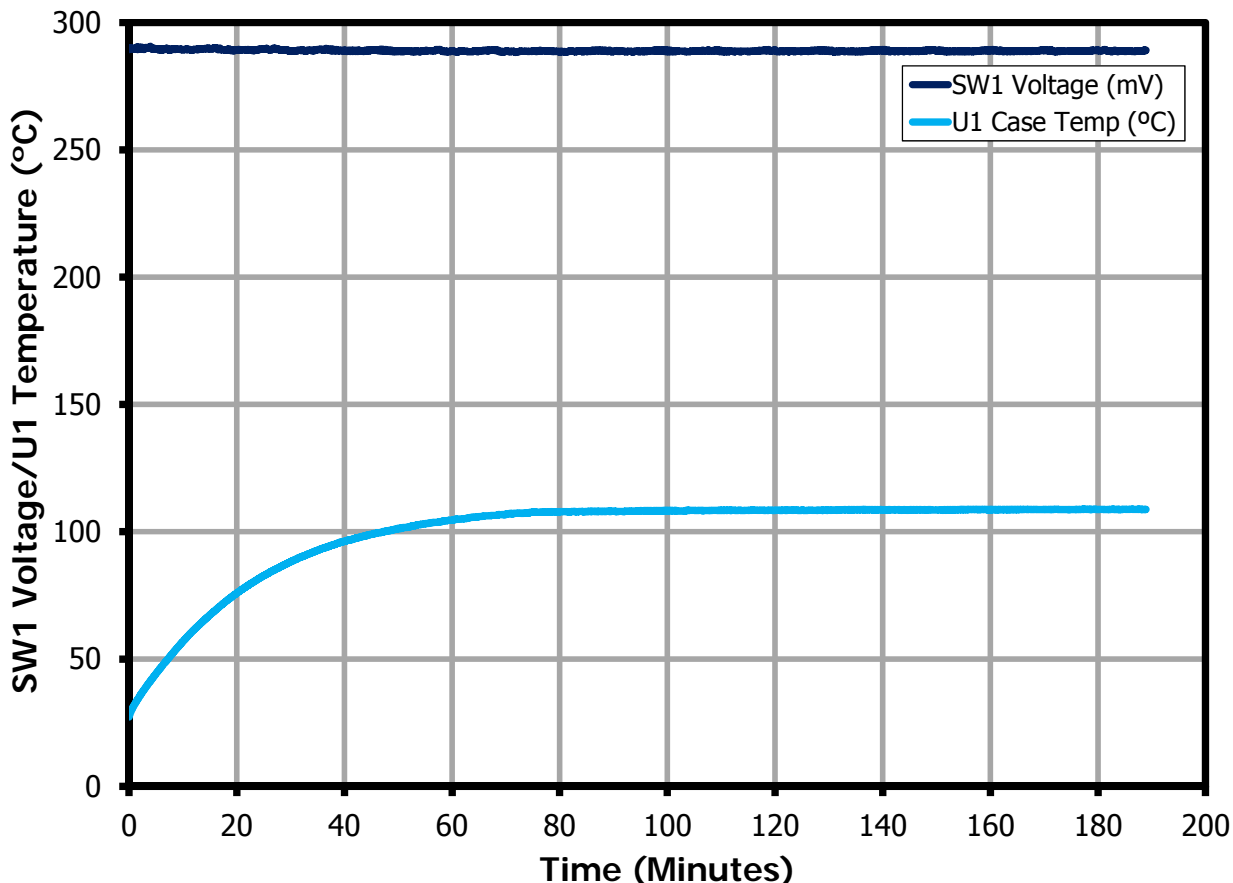

Figure 36 – Thermal Profile for DER-580 Using TOP268EG for U1, 25C Ambient, 230 VAC.

When a TOP268EG was substituted for U1, the supply ran continuously in full current limit mode for more than three hours (Figure 36). Case temperature of U1 reached equilibrium at 109 °C.

When the supply is operated at elevated ambient temperatures, the time at maximum current limit will be shorter, with a longer time spent at reduced current limit. At sufficiently high ambient temperature, the SW1 thermal switch will trip and not reset, as the heat sink will no longer cool down to the SW1 70 °C reset temperature. As a result, the supply will run continuously at reduced current limit until the ambient temperature cools sufficiently to allow SW1 to reset.

12.1.1 180 VAC, 50 Hz, Room Temperature, Open Air 100% Load Overall Temperature Profile

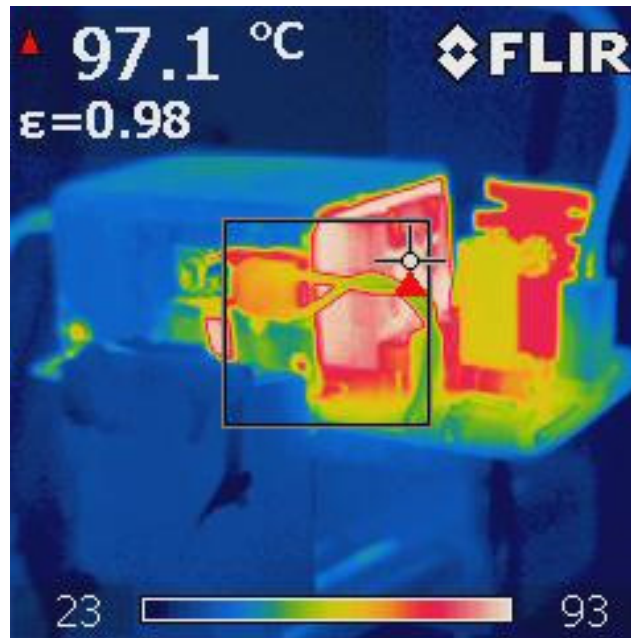

Figure 37 – Top View Thermal Picture, 180 VAC.

13 Gain-Phase

13.1 Main Output Constant Voltage Mode Gain-Phase

For these measurements the electronic load was set to constant current mode, with the output current just below the current limit (~1.7 A), in order to determine the characteristics of the voltage regulation loop. Measurements were taken at 180 VAC and 230 VAC. The loop was broken at the TOPSwitch (U1) control pin using the current injection technique detailed in PI application note AN-57. This measurement technique causes the phase to be displayed as shown in Figure 38. The resulting phase value must be added to 180 to obtain the actual phase margin.

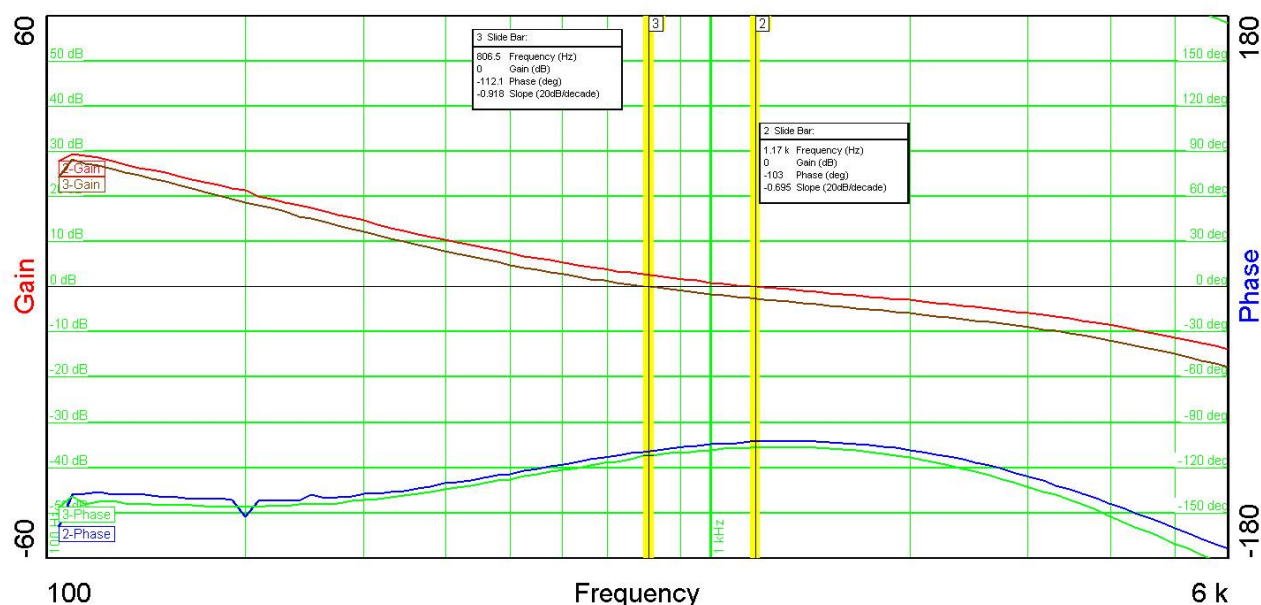

Figure 38 – Main Output Gain-Phase, Voltage Loop, Chroma Constant Current Load Set to 1.7 ADC.
 Red/Blu – 230 VAC Gain and Phase Crossover Frequency – 1170 Hz, Phase Margin – 77°.
 Brn/Grn – 180 VAC Gain and Phase Crossover Frequency – 806.5 Hz, Phase Margin – 68°.

13.2 Main Output Constant Current Mode Gain-Phase

Current loop gain-phase was tested using a Chroma electronic load set to constant voltage mode at three set points - 57 V, 30 V, and 15 V, obtaining the gain-phase measurements for three widely separated points on the V-I characteristic curve. Using a CV load maximizes the CC loop gain (worst case for control loop) and simulates operating while charging a low impedance load like a battery. Using the constant resistance setting for the electronic load will yield overly optimistic results for gain-phase measurements and for determining component values for frequency compensation. Measurements were taken at 180 VAC and 230 VAC for each output voltage setting. The current control loop could be measured in a similar fashion to the voltage control loop using current injection. However, in this example, the current control loop was broken by placing a 47 Ω injection between R31 and secondary return. This point is used for voltage injection and loop sensing. The resulting graph displays phase margin directly, unlike the current injection technique.

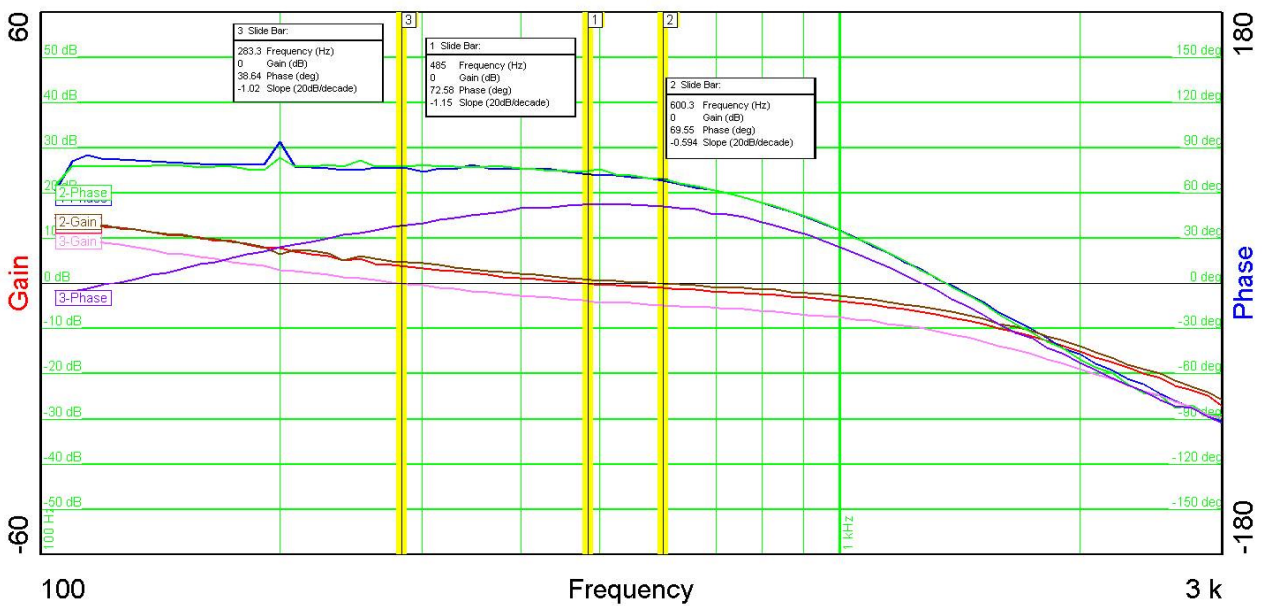

Figure 39 – Main Output Gain-Phase, Current Loop, 230 VAC, Chroma Constant Voltage Load
 Red/Blu – 57 V Output Gain and Phase Crossover Frequency – 485 Hz, Phase Margin – 72.6°.
 Brn/Grn – 30 V Output Gain and Phase Crossover Frequency – 600 Hz, Phase Margin – 69.6°.
 Pnk/Pur – 15 V Output Gain and Phase Crossover Frequency – 283 Hz, Phase Margin – 38.6°.



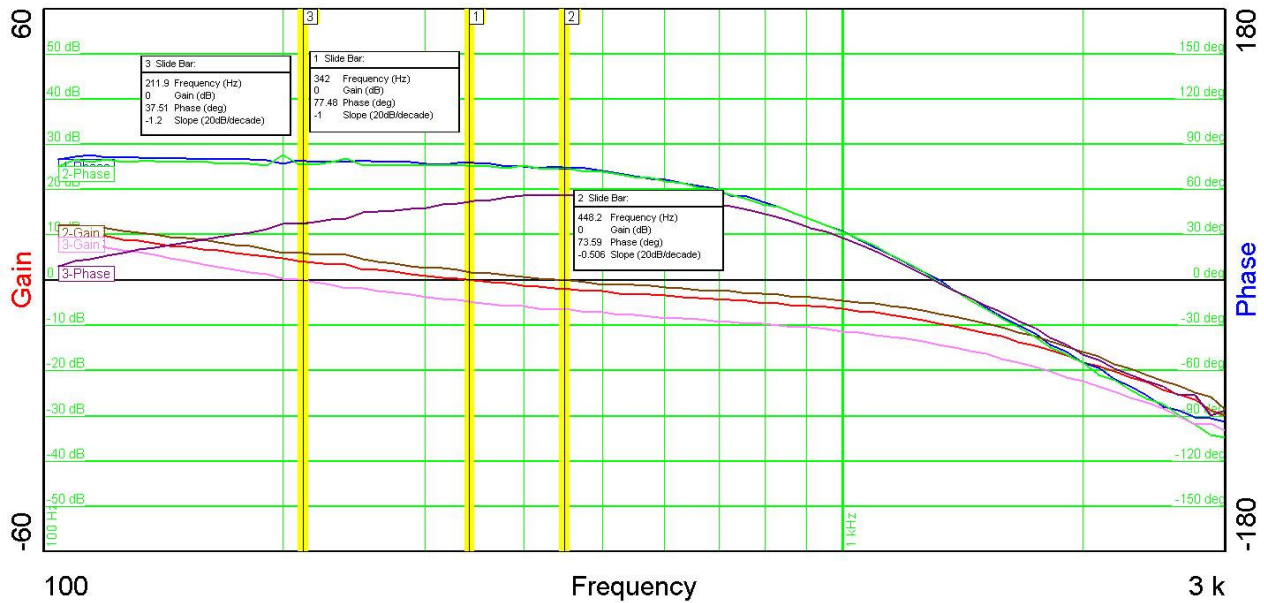

Figure 40 – Main Output Gain-Phase, Current Loop, Chroma Constant Voltage Load 180 VAC Input.
 Red/Blu – 57 V Output Gain and Phase Crossover Frequency – 342 Hz, Phase Margin – 77.5°.
 Brn/Grn – 30 V Output Gain and Phase Crossover Frequency – 448 Hz, Phase Margin – 73.6°.
 Pnk/Pur – 15 V Output Gain and Phase Crossover Frequency – 212 Hz, Phase Margin – 37.5°.



14 Conducted EMI

Conducted EMI tests were performed using a 32 Ω floating resistive load. An actual 2-wire input cord was used for EMI measurements.

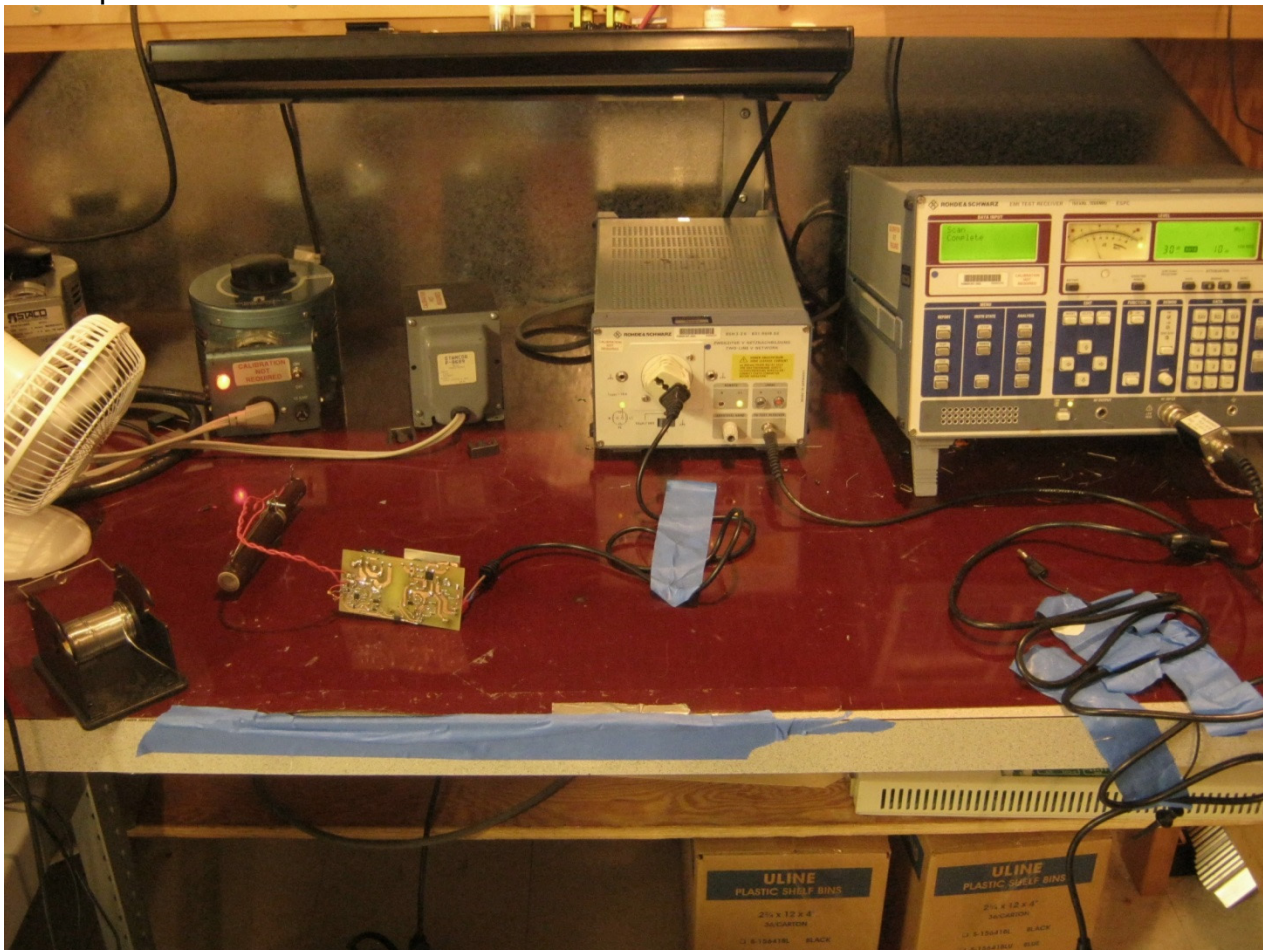

Figure 41 – EMI Set-up with Floating Resistive Load.

14.1 Conducted EMI Scan

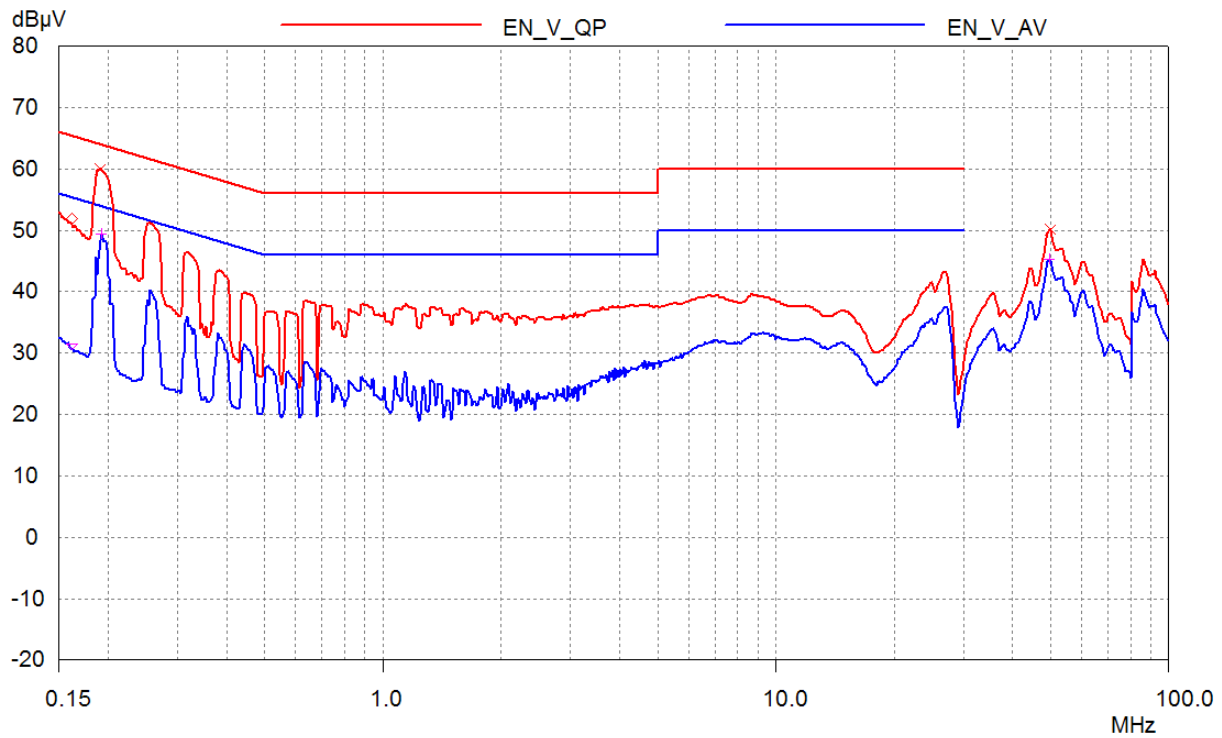

Figure 42 – Conducted EMI, 230 VAC, 32 Ω Floating Resistive Load.

15 Revision History

Date	Author	Revision	Description & changes	Reviewed
06-Dec-16	RH	1.0	Initial Release.	Apps & Mktg
20-Dec-16	RH	1.1	Updated Heat Sink Drawings.	
19-Sep-17	KM	1.2	Added Magnetics Supplier for T1 and L2.	



For the latest updates, visit our website: www.power.com

Power Integrations reserves the right to make changes to its products at any time to improve reliability or manufacturability. Power Integrations does not assume any liability arising from the use of any device or circuit described herein. POWER INTEGRATIONS MAKES NO WARRANTY HEREIN AND SPECIFICALLY DISCLAIMS ALL WARRANTIES INCLUDING, WITHOUT LIMITATION, THE IMPLIED WARRANTIES OF MERCHANTABILITY, FITNESS FOR A PARTICULAR PURPOSE, AND NON-INFRINGEMENT OF THIRD PARTY RIGHTS.

Patent Information

The products and applications illustrated herein (including transformer construction and circuits' external to the products) may be covered by one or more U.S. and foreign patents, or potentially by pending U.S. and foreign patent applications assigned to Power Integrations. A complete list of Power Integrations' patents may be found at www.power.com. Power Integrations grants its customers a license under certain patent rights as set forth at <http://www.power.com/ip.htm>.

The PI Logo, TOPSwitch, TinySwitch, LinkSwitch, LYTSwitch, InnoSwitch, DPA-Switch, PeakSwitch, CAPZero, SENZero, LinkZero, HiperPFS, HiperTFS, HiperLCS, Qspeed, EcoSmart, Clampless, E-Shield, Filterfuse, FluxLink, StackFET, PI Expert and PI FACTS are trademarks of Power Integrations, Inc. Other trademarks are property of their respective companies. ©Copyright 2015 Power Integrations, Inc.

Power Integrations Worldwide Sales Support Locations

WORLD HEADQUARTERS

5245 Hellyer Avenue
San Jose, CA 95138, USA.
Main: +1-408-414-9200
Customer Service:
Phone: +1-408-414-9665
Fax: +1-408-414-9765
e-mail: usasales@power.com

GERMANY

Lindwurmstrasse 114
80337, Munich
Germany
Phone: +49-895-527-39110
Fax: +49-895-527-39200
e-mail: eurosales@power.com

JAPAN

Kosei Dai-3 Building
2-12-11, Shin-Yokohama,
Kohoku-ku, Yokohama-shi,
Kanagawa 222-0033
Japan
Phone: +81-45-471-1021
Fax: +81-45-471-3717
e-mail: japansales@power.com

TAIWAN

5F, No. 318, Nei Hu Rd.,
Sec. 1
Nei Hu District
Taipei 11493, Taiwan R.O.C.
Phone: +886-2-2659-4570
Fax: +886-2-2659-4550
e-mail:
taiwansales@power.com

CHINA (SHANGHAI)

Rm 2410, Charity Plaza, No. 88,
North Caoxi Road,
Shanghai, PRC 200030
Phone: +86-21-6354-6323
Fax: +86-21-6354-6325
e-mail: chinasales@power.com

INDIA

#1, 14th Main Road
Vasanthanagar
Bangalore-560052
India
Phone: +91-80-4113-8020
Fax: +91-80-4113-8023
e-mail: indiasales@power.com

KOREA

RM 602, 6FL
Korea City Air Terminal B/D,
159-6
Samsung-Dong, Kangnam-Gu,
Seoul, 135-728 Korea
Phone: +82-2-2016-6610
Fax: +82-2-2016-6630
e-mail: koreasales@power.com

UK

Cambridge Semiconductor,
a Power Integrations company
Westbrook Centre, Block 5,
2nd Floor
Milton Road
Cambridge CB4 1YG
Phone: +44 (0) 1223-446483
e-mail: eurosales@power.com

CHINA (SHENZHEN)

17/F, Hivac Building, No. 2, Keji
Nan 8th Road, Nanshan District,
Shenzhen, China, 518057
Phone: +86-755-8672-8689
Fax: +86-755-8672-8690
e-mail: chinasales@power.com

ITALY

Via Milanese 20, 3rd Fl.
20099 Sesto San Giovanni (MI)
Italy
Phone: +39-024-550-8701
Fax: +39-028-928-6009
e-mail: eurosales@power.com

SINGAPORE

51 Newton Road,
#19-01/05 Goldhill Plaza
Singapore, 308900
Phone: +65-6358-2160
Fax: +65-6358-2015
e-mail: singaporesales@power.com



Power Integrations, Inc.

Tel: +1 408 414 9200 Fax: +1 408 414 9201
www.power.com